

# ROUND CANOVA

Diffuser in gypsum for plasterboard

- cod. PWD200028 - cod. PWD200029 - cod. PWD200030

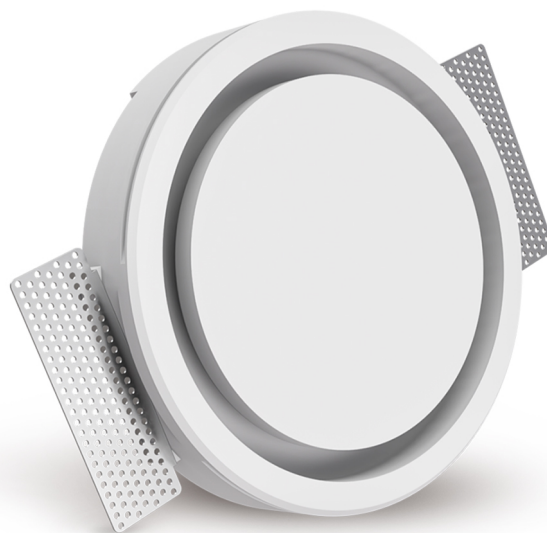

## DESCRIPTION

The diffuser made of plaster, round and square, is an essential element to be inserted into the ceiling or walls in plasterboard. It can be painted with the same color of the surface in which it is placed, integrating perfectly thanks to the minimal ring slit, necessary for the passage of air.

## TECHNICAL SPECIFICATIONS

- Hidden and frameless
- High-quality gypsum products
- Can be installed on all types of ducts (steel, corrugated plastic, plenum)
- Connections for 100 mm, 125 mm and 160 mm pipes
- Can be used on single layer, double layer or variable thickness plasterboard
- Sturdy magnetic supports in stainless steel
- Side flaps for stucco fixing
- Diffusion profile ensuring uniform air distribution

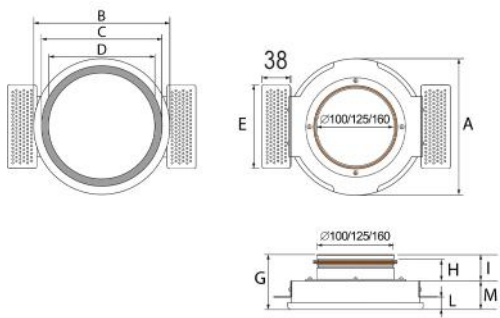

## DIMENSIONS

CODE	A [mm]	B [mm]	C [mm]	D [mm]	E [mm]	G [mm]	H [mm]	I [mm]	L [mm]	M [mm]
PWD200028	234	238	206	176	120	89	35	41	13-26	48
PWD200029	234	238	206	176	120	89	35	41	13-26	48
PWD200030	296		266	232	173	91	35	41	13-26	50

## AIR FLOW RATE DIAGRAMS

**Canova Ø 100 (mandata / supply air)**

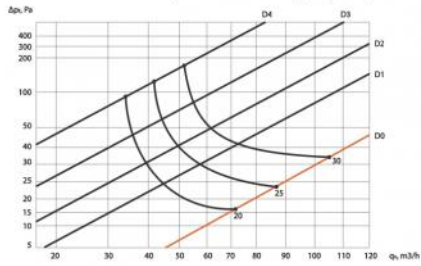

**Canova Ø 125 (mandata / supply air)**

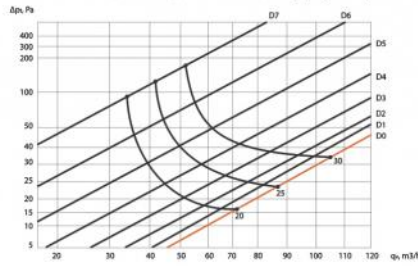

**Canova Ø 160 (mandata / supply air)**

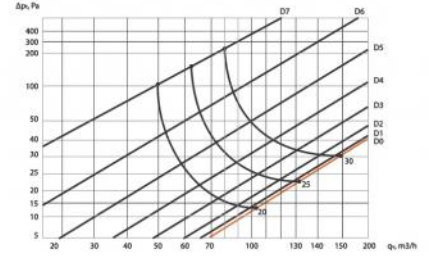

**Canova Ø 100 (estrazione / exhaust air)**

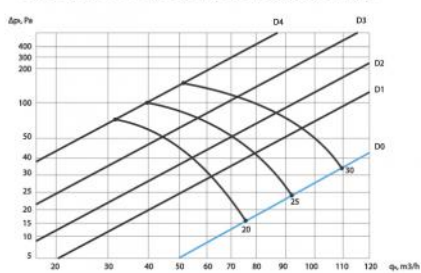

**Canova Ø 125 (estrazione / exhaust air)**

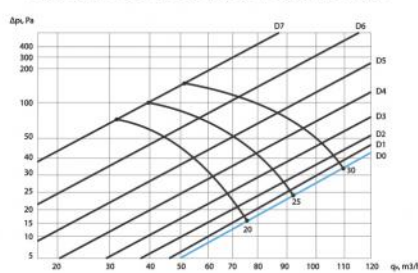

**Canova Ø 160 (estrazione / exhaust air)**

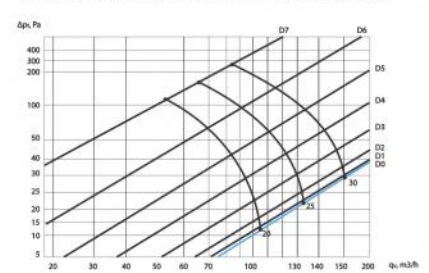

**Canova Ø 100/125  
velocità / velocity m/s**

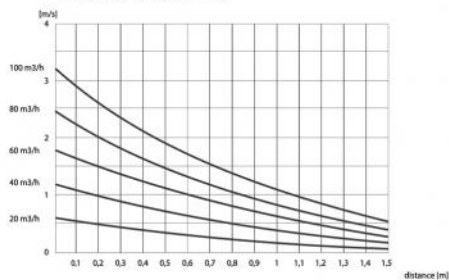

**Canova Ø 160  
velocità / velocity m/s**

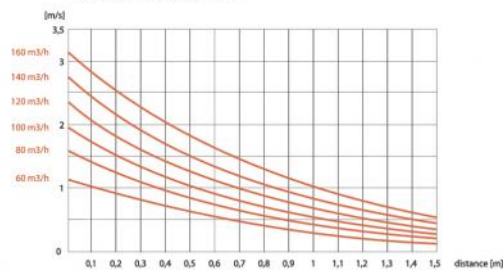

## ITEMS

CODE	DESCRIPTION
PWD200028	CANOVA ROUND DIFFUSER DIAMETER 100
PWD200029	CANOVA ROUND DIFFUSER DIAMETER 125
PWD200030	CANOVA ROUND DIFFUSER DIAMETER 160

All rights relating to this publication are the exclusive property of Tecnosystemi SpA.

Tecnosystemi SpA reserves the right to make changes at any time and without notice, for technical or commercial needs.