

Tangential air curtain with upper extraction

- cod. 12300050I - cod. 12300051I - cod. 12300055I
- cod. 12300056I



TECHNICAL SPECIFICATIONS:

- 4 models in white
- 3 speeds operated by remote control
- Air curtains are designed for indoor use
- Panel with 3 LEDs
- Automatic starter kit on request
- Upper air intake
- The unit must be installed horizontally

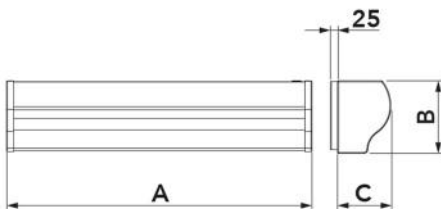

DIMENSIONS

CODE	A [mm]	B [mm]	C [mm]	SUITABLE FOR DOORS [mm]	WEIGHT [kg]
12300050I	1085	250	185	L1000 H3000	13,3
12300051I	1085	250	185	L1000 H3000	13,3
12300055I	1440	250	185	L1500 H3000	19,2
12300056I	2040	250	185	L2000 H3000	27,5

TECHNICAL DATA

CODE	MODEL	SUPPLY VOLTAGE [V]	FREQUENCY [Hz]	POWER CONSUMPTION [W]	AIR SPEED AT INLET [m/s]	AIR FLOW RATE [m³/h]	SOUND POWER LEVEL [DB(A)]	REMOTE CONTROL
12300050I	1100 right single fan	230 ac	50	75	I:8 II:9 III:10	765 846 918	61 64 66	3-speed adjustment
12300051I	1100 left single fan	230 ac	50	75	I:8 II:9 III:10	765 846 918	61 64 66	3-speed adjustment
12300055I	1500 central double fan	230 ac	50	190	I:8 II:9 III:10	1350 1458 1512	66 68 69	3-speed adjustment
12300056I	2000 central double fan	230 ac	50	190	I:8 II:9 III:10	1494 1692 1818	64 66 68	3-speed adjustment

REMOTE CONTROL

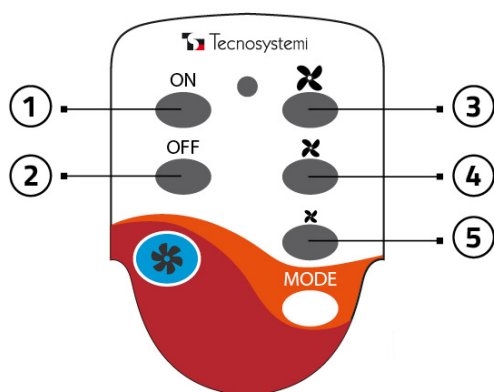

- [1] ON / Turns the appliance on
- [2] OFF / Shuts the appliance off
- [3] Maximum speed
- [4] Medium speed
- [5] Low speed

DASHBOARD LABEL

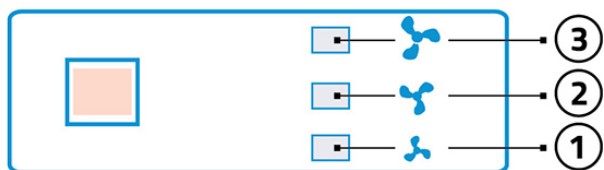

- [1] 1st speed (Min) 1 LED LIT
- [2] 2nd speed (Med) 2 LEDS LIT
- [3] 3rd speed (Max) 3 LEDS LIT

AUTOMATIC START KIT FOR AIR CURTAINS.



This kit, sold separately from the air curtain, allows you to switch the machine on and off by opening and closing the door.

INSTALLING AND COMMISSIONING THE AUTOMATIC START KIT (optional)

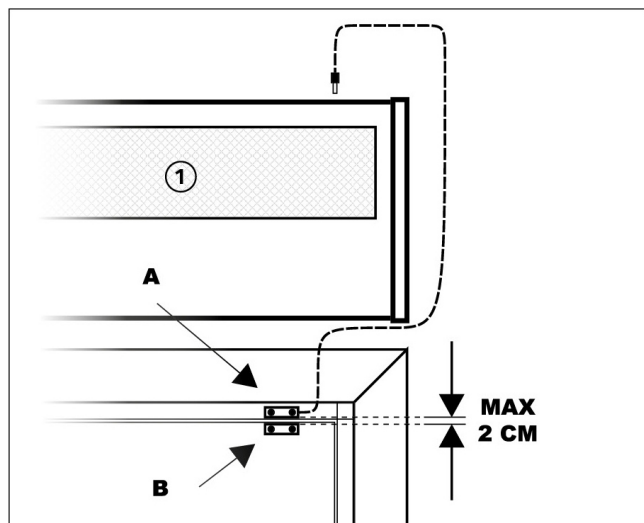

[1] Air curtain

Connect the wired sensor to the air curtain via jack.
Attach the magnetic sensor A to the door casing or to a solid point with the door frame.
Attach the second sensor to the moving part of the door leaving no more than 2 cm between the two sensors.
When the "automatic start kit" is installed, the air curtain can be switched on and off with the opening / closing of the door.

WALL-MOUNTED DRILLING SPACING MODEL 1100 RH/LH

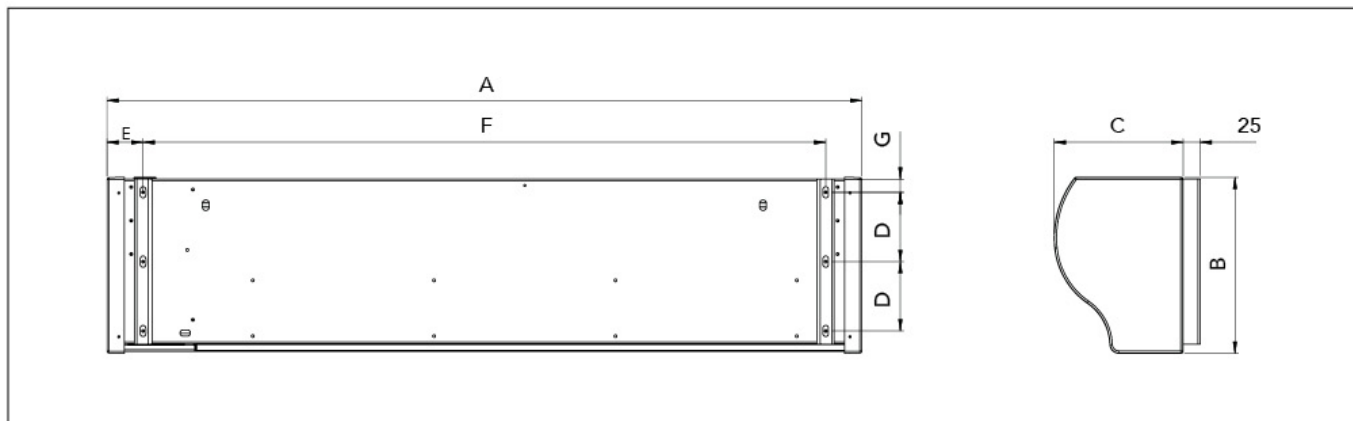

DIMENSIONAL TABLE

CODE	A [mm]	B [mm]	C [mm]	D [mm]	E [mm]	F [mm]	G [mm]
12300050I	1085	250	185	99	52	980	20
12300051I	1085	250	185	99	52	980	20

WALL-MOUNTED DRILLING SPACING MODEL 1500 CENTRAL

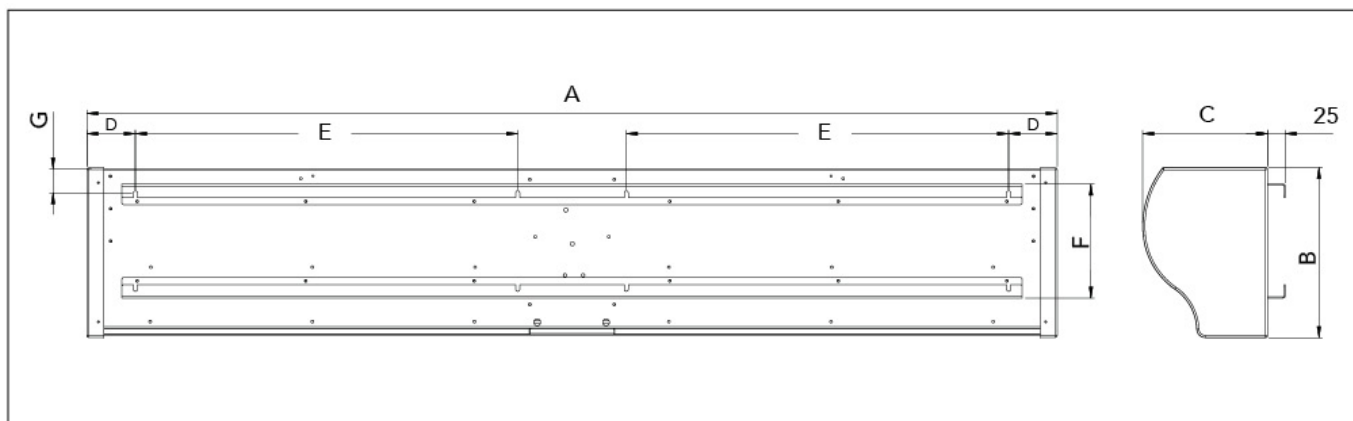

DIMENSIONAL TABLE

CODE	A [mm]	B [mm]	C [mm]	D [mm]	E [mm]	F [mm]	G [mm]
12300050I	1440	250	185	72	566	170	35

WALL-MOUNTED DRILLING SPACING MODEL 2000 CENTRAL

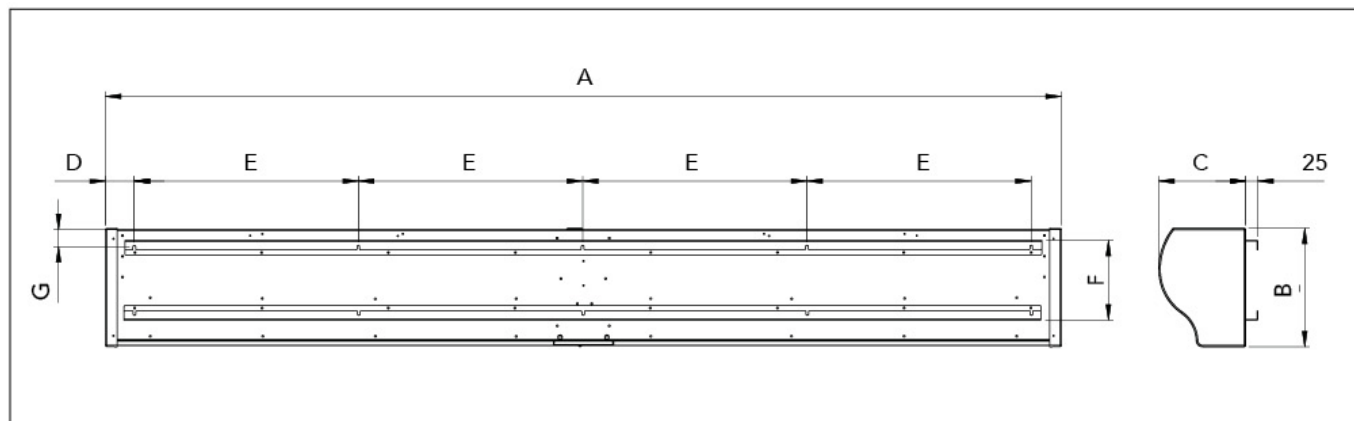

DIMENSIONAL TABLE

CODE	A [mm]	B [mm]	C [mm]	D [mm]	E [mm]	F [mm]	G [mm]
12300050I	2040	250	185	67	478	170	35

DIMENSIONAL TABLE

CODE	A [mm]	B [mm]	C [mm]	D [mm]	E [mm]	F [mm]	G [mm]
12300050I	2040	250	185	67	478	170	35

ITEMS

CODE	DESCRIPTION
12300050I	"ARIA3 SILENCE" TANGENTIAL SINGLE-FAN AIR CURTAINS 1100 DX
12300051I	"ARIA3 SILENCE" TANGENTIAL SINGLE-FAN AIR CURTAINS 1100 SX
12300055I	"ARIA3 SILENCE" TANGENTIAL DUAL-FAN AIR CURTAINS 1500 CEN.
12300056I	"ARIA3 SILENCE" TANGENTIAL DUAL-FAN AIR CURTAINS 2000 CEN.

All rights relating to this publication are the exclusive property of Tecnosystemi SpA.

Tecnosystemi SpA reserves the right to make changes at any time and without notice, for technical or commercial needs.