

Insulated box in sheet metal for flexible ducted pipe 4 - 6 - 8 - 10 - 12 outputs \varnothing 75

- cod. ACD600005 - cod. ACD600008 - cod. ACD600011
- cod. ACD600014 - cod. ACD600017 - cod. ACD600059
- cod. ACD600060



TECHNICAL SPECIFICATIONS:

- Made of galvanized sheet metal
- External insulation in 3 mm thick polyethylene
- Air intake collar supplied
- Outgoing collars as shown in the table
- Complete with brackets for ceiling mounting

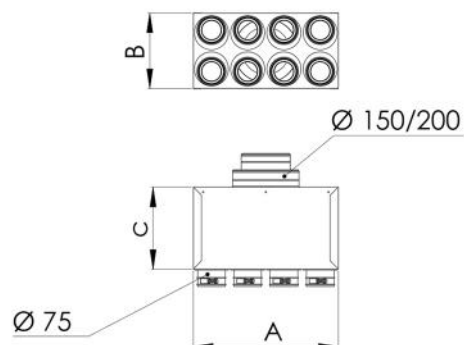

DIMENSIONS

CODE	A [mm]	B [mm]	C [mm]	INPUT Ø [mm]	No.of OUTLETS - Ø [mm]
ACD600005	220	230	250	150 / 200	4 - 75
ACD600008	330	230	250	150 / 200	6 - 75
ACD600011	440	230	250	150 / 200	8 - 75
ACD600014	550	230	250	150 / 200	10 - 75
ACD600017	660	230	250	150 / 200	12 - 75
ACD600059	220	230	250	100 / 125 / 150	4 - 75
ACD600060	330	230	250	100 / 125 / 150	6 - 75

ITEMS

CODE	DESCRIPTION
ACD600005	INSULATED SHEET METAL PLENUM FOR FLEXIBLE HOSE WITH 4 OUTLETS, Ø75
ACD600008	INSULATED SHEET METAL PLENUM FOR FLEXIBLE HOSE WITH 6 OUTLETS, Ø75
ACD600011	INSULATED SHEET METAL PLENUM FOR FLEXIBLE HOSE WITH 8 OUTLETS, Ø75
ACD600014	INSULATED SHEET METAL PLENUM FOR FLEXIBLE HOSE WITH 10 OUTLETS, Ø75
ACD600017	INSULATED SHEET METAL PLENUM FOR FLEXIBLE HOSE WITH 12 OUTLETS, Ø75
ACD600059	
ACD600060	

All rights relating to this publication are the exclusive property of Tecnosystemi SpA.

Tecnosystemi SpA reserves the right to make changes at any time and without notice, for technical or commercial needs.