

# CATALOGUE NEWS 2025

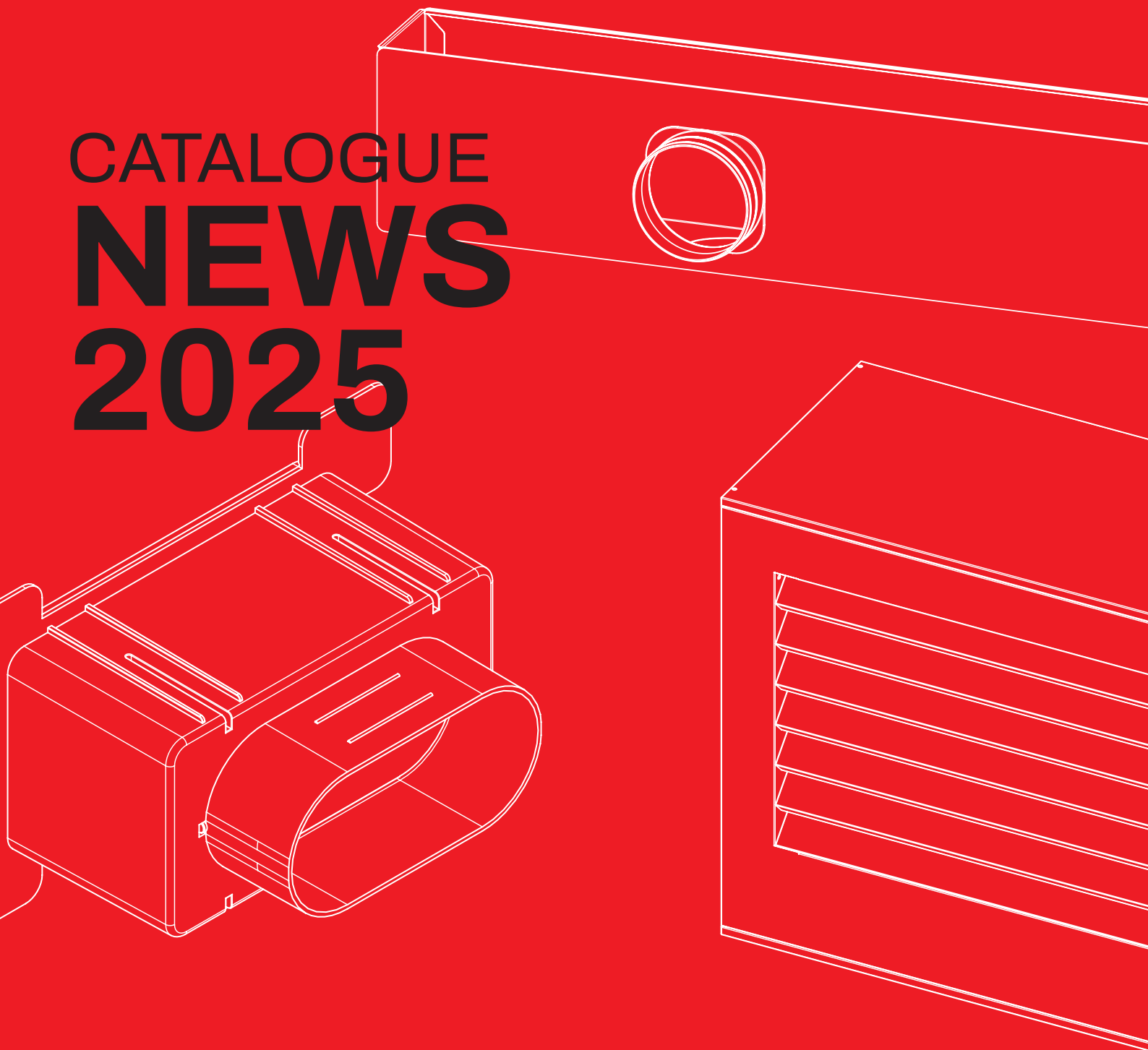

**Smart Clima**

Accessories for Air Conditioning



**Apply Air**

Air Curtains and Accessories



**Apply.Co**

Mechanical Controlled Ventilation



**Galaxy**

Multi-Zone Air Control System



**Project Wind**

Ventilation Solutions



**Toolsplit**

Instruments & Tools



**Showgas**

Heating Products



**FV Power**

Photovoltaic Fixing Elements

[www.tecnosystemi.com](http://www.tecnosystemi.com)

# INDEX



**Smart Clima**

Accessories for Air Conditioning

Page 18



**Apply.Co**

Mechanical Controlled Ventilation

Page 38



**Galaxy**

Multi-Zone Air Control System

Page 41



**Project Wind**

Ventilation Solutions

Page 43



**Toolsplit**

Instruments & Tools

Page 50

# TECNOSYSTEMI'S HISTORY OF VALUE



**1992**

## THE FIRST TECNOSYSTEMI IS FOUNDED

Officially established in 1992, the company began its journey at its first location in Susegana.



**2002**

## TRANSFER TO VITTORIO VENETO

Tecnosystemi moved to a 33,000 square metre site in the industrial area of Vittorio Veneto, after changing the plant location twice.



**2017**

## PHOTOVOLTAIC SYSTEM INSTALLATION 500 kW

In 2017, when renovating the old warehouses, the company decided to install a 500 Kw photovoltaic system on the entire roof surface, creating a system that covers the energy needs of production without producing harmful emissions.

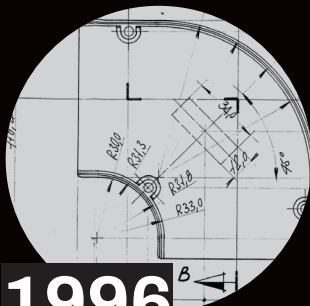

**1996**

## THE TRANSITION TO A MANUFACTURING COMPANY

One of the first major transformations led the company to begin a virtuous path that is still evolving today.

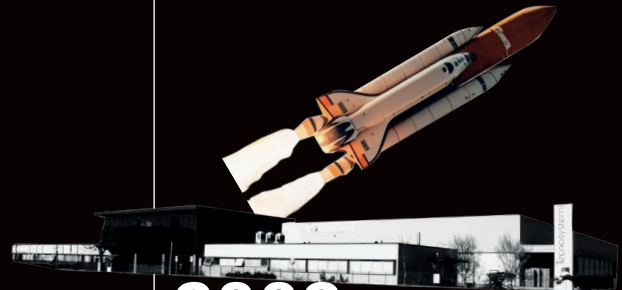

**2003**

## A STRATEGIC CHANGE OF PERSPECTIVE TOWARDS THE FUTURE

The company evolves into the current company structure marking its definitive take-off.



**2020**

**TECNOSYSTEMI REDESIGNS THE HEADQUARTERS**

The headquarters were redesigned, modernising the outdated building that was not in keeping with the company's vision.



**2022**

**COMPLETION OF THE PHOTOVOLTAIC SYSTEM**

At the beginning of 2022, the photovoltaic system was completed, which with its 1.2 MW output covers 85% of Tecnosystemi's production requirements.



**2019**

**EXTENSION OF THE PRODUCTION PLANT**

Facing major business developments, and choosing to internalise more and more production processes, an extension of around 6,000 m<sup>2</sup> was required, and the production plant now covers over 19,000 m<sup>2</sup>



**2021**

**TECNOSYSTEMI BECOMES A BENEFIT COMPANY**

The company becomes a Benefit Company: by redefining its corporate purpose, it makes a firm commitment to making a positive impact on the environment and the community, effectively continuing a journey that began years earlier.



**2023**

**A NEW PRODUCTION PLANT**

With continued growth and a vision always open to large projects, Tecnosystemi expands with the acquisition of another new 12,000 m<sup>2</sup> plant on a 25,500 m<sup>2</sup> site in December 2022. The energy transition continues with the expansion of the photovoltaic system on the company's two plants for a total installed capacity of 1.6 MW.

# HIGHLIGHTS

## THE GROUP

over **30**  
years of business  
experience

**8**  
brands

**18,781,525**  
pieces produced in 2024 only

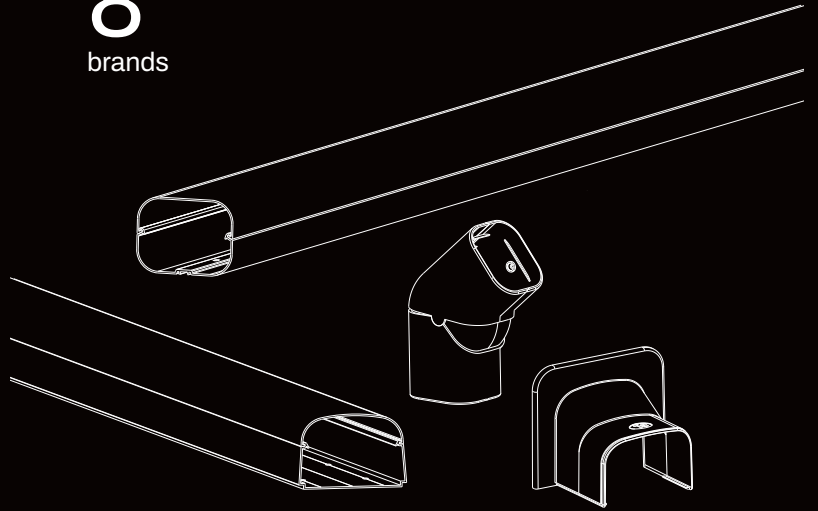

**6,434**  
catalogue items

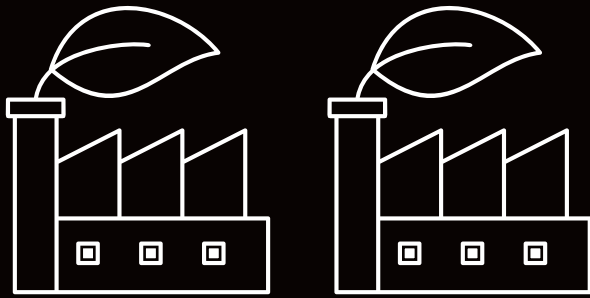

**2**  
production  
plants

**32,000** sqm  
total production area

**5**  
days lead time



## PEOPLE

**200**  
direct and indirect  
employees

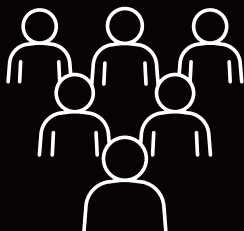

**4,000**  
training hours  
provided in 2023

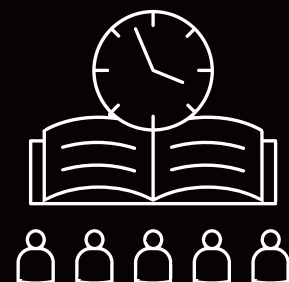

## THE SUPPLY CHAIN

**+300**  
suppliers of goods  
and services

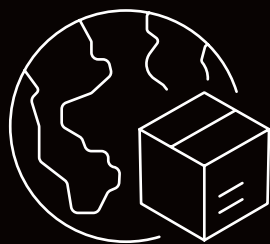

**77 %**  
Italian suppliers

**41 %**  
suppliers from  
Veneto

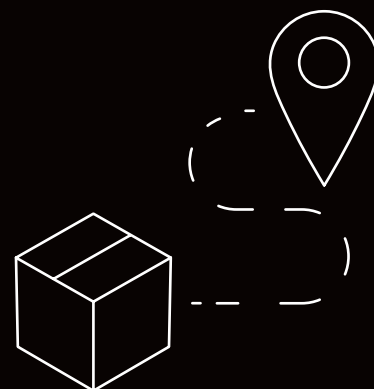

## THE ENVIRONMENT

**4,806**  
panels installed

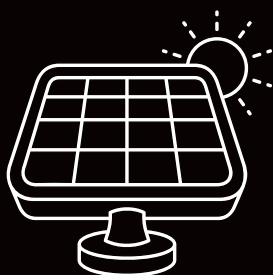

**1.6 MW**  
total installed power

**49 %**  
electricity used in the  
company comes from  
renewable sources

**-22 %**  
emissions per piece  
produced in 2023  
compared to 2022

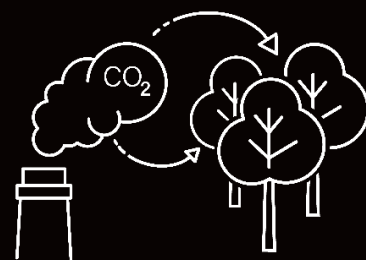

## OUR CERTIFICATIONS



\* See the certified  
wall brackets



# PRODUCTION COMPANY







# PRODUCTION COMPANY

## PLANT 1



# PLANT 2

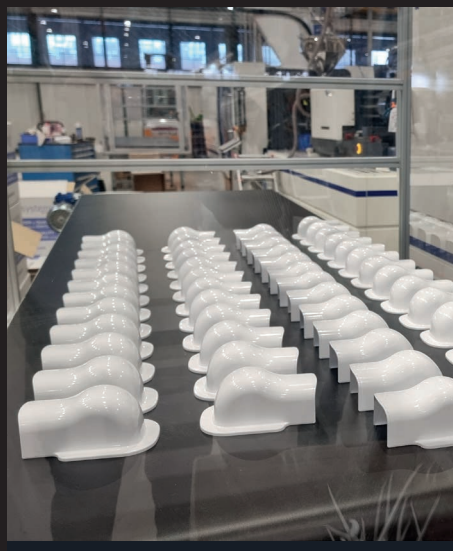

# A NEW DEVELOPMENT MODEL: WHEN SUSTAINABILITY BECOMES A RESPONSIBILITY

Civil responsibility and transparency are our core values, underpinning a model of entrepreneurship that looks beyond the confines of the company to embrace a civil duty, caring for people, the land, the environment and the community.

A new way of working and being a company, with a defined and precise role, which led us to decide to become a Benefit Company in order to go beyond the word “sustainability”. A solid commitment that began with an important choice: the change of our company name and Articles of Association. We chose the **Benefit Company** model because we believe that our stakeholders need clarity and facts. Actions that must be thought out, planned and shared. We cannot do business without considering our impacts, of which we are absolutely responsible for and aware of.

We decided to focus our business on four key topics, known as purposes of common good, which we measure, disclose and report every year with facts and figures to correctly engage our various stakeholders.





  
**OUR  
GREATEST  
VALUE  
IS OUR TEAM**

# MANAGEMENT SYSTEMS, CERTIFICATIONS, ITALIAN MANUFACTURING.



Through investments in new technologies, the continuous improvement of our processes and the enhancement of skills, our research and development division develops high-quality, functional and cutting-edge products.

Supporting these processes, we launched a programme of progressive implementation of **management systems certified by external bodies**.

The basis is the **ISO 9001:2015** system, which guarantees a **well-organised business structure** that is improved continuously.

With the **ISO 45001:2018** certification for **health and safety**, we have structured a safe working environment that has the interests of all our people at heart.

Increasingly attentive to environmental impacts, we have begun to implement an **environmental management system** conforming to standard **UNI EN ISO 14001:2015**, but in addition, from 2024 we use **energy** produced exclusively by our **photovoltaic panels** and we purchase energy **only from 100% renewable sources**.

In terms of our production, we have selected some products for **TÜV SÜD certification**, which offers a further guarantee of quality and safety for installation.

Furthermore, having completed the LCA analysis on several core-business product lines, we have begun **EPD certification**, in accordance with the key strategic commercial international certification analysis standard, which should be completed in 2025

## OUR CERTIFICATIONS



\*See the certified wall brackets

# WE ARE AN ITALIAN EXCELLENCE, CERTIFIED BY ITALYx



ITALYx

CERTIFIED ITALIAN EXCELLENCE

Il Sole  
24 ORE

PROMOSSO DA  
CONFINDUSTRIA

In November 2024, we obtained a major certification that celebrates our commitment to representing and **promoting Italian manufacturing** throughout the production chain, which acknowledges our ability to conceive, design and innovate in line with the distinctive features of Italian tradition.

The certification is awarded on the basis of a very strict technical specification set by **Il Sole 24 Ore**, and audited by **Bureau Veritas**, an independent certification agency. The main requirements and parameters certifying the Italian excellence of its products include: **design, production, ownership and R&D in Italy; high standards of style and creativity; Italian suppliers and subcontractors; Italian patents.**

## THE VALUE OF CERTIFICATION



Recognition  
of quality



International  
visibility



Enhancing Italian  
excellence



Committed to innovation

# A CONSCIOUS STUDY, TO RETHINK OUR PACKAGING.

Did you know that 95% of the packagings we use are made from renewable materials?

Our sustainable innovation is based on research into solutions that generate **the least possible environmental impact**, including the packaging we use to pack and ship our products. Precisely for this purpose, we have launched an assessment of our packaging materials, choosing to redesign our packaging by preferring recyclable materials and **water- or soy-based inks**, which are safer and less polluting as they contain no solvents and need less energy to dry than common inks.

Packaging that respects the planet and consciously respects our future.



# WE USE 100% GREEN-CERTIFIED RENEWABLE ENERGY



From this year, all the electricity that is not produced by our photovoltaic plants comes from other renewable sources.

We respect the environment using only energy produced from renewable sources, including water, sun, wind and geothermal, certified by the “guarantee of origin” system run by the energy services manager, in accordance with Directive (EC) 2009/28/EC.





# WE NEVER STOP IMPROVING: OUR EPD CERTIFICATION PATH.



**EPDs - Environmental Product Declarations** - are transparency documents that inform of our commitment to measuring environmental impacts linked to our production activities, describing them clearly and precisely.

The process is structured into various phases, is based on international standards and considers the whole product life cycle.

This year we launched our **first EPD certification on duct lines and Excellens and Optima white accessories**, quantifying the energy and natural resources used in the production and distribution processes, the CO<sub>2</sub> emissions into the atmosphere, the materials used for packaging and the waste generated.

Scan the QR Code to keep up-to-date on our EPD-certified products.



## THE 5 EPD DEVELOPMENT PHASES



PCR verification



Life Cycle Assessment



Drafting



Accreditation



Registration and publication

# NEW INNOVATIVE MATERIAL FOR AN EXTRAORDINARY RESULT

Trunkings and accessories made  
in PVC and plastic material



Patented model



Anti UV rays



Reach certifications



High resistance



Eco-friendly material



Shockproof



Operating temperature  
-20°C/+75°C

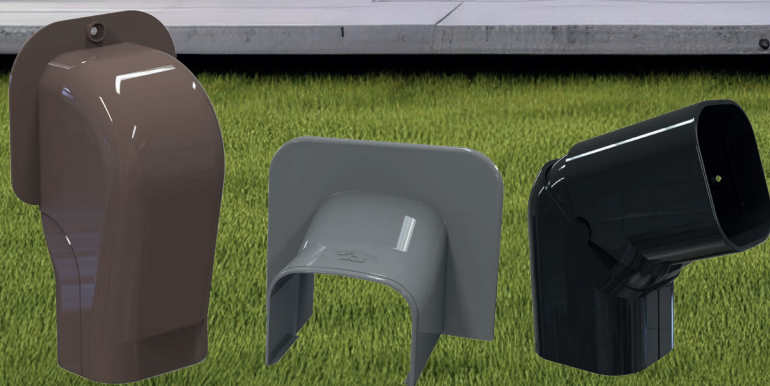

excellens

Optima

MADE IN ITALY

## EXCELLENS TMR

MADE IN ITALY

WALL-MOUNTED TERMINAL, ROUND

EXTRÉMITÉ MURALE RONDE

RUNDER WANDABSCHLUSS

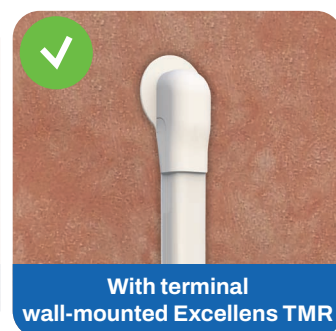
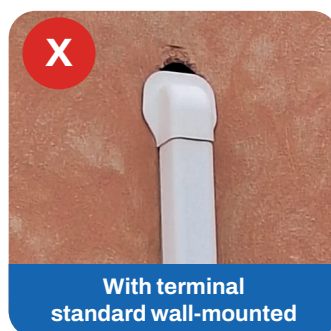

THE IDEAL SOLUTION TO COVER UP ERRORS DURING WALL CORING OPERATIONS

Large outer flange with an innovative round shape

MODEL	TOP LINE	NEW LINE	ECO LINE	BROWN LINE	BLACK LINE	GREY LINE	M.U.	Multiple order M.U.
	CODE	CODE	CODE	CODE	CODE	CODE		
TMR 60-EXC	SCD100274	SCD100280	SCD100286	SCD100292	SCD100298	SCD100304	PCS	5
TMR 72-EXC	SCD100276	SCD100282	SCD100288	SCD100294	SCD100300	SCD100306	PCS	5
TMR 100-EXC	SCD100278	SCD100284	SCD100290	SCD100296	SCD100302	SCD100308	PCS	3

## EXCELLENS TMQ

MADE IN ITALY

WALL-MOUNTED TERMINAL, SQUARE

EXTRÉMITÉ MURALE CARRÉE

QUADRATISCHER WANDABSCHLUSS



AVAILABLE FROM FEBRUARY 2025

AVAILABLE FROM MARCH 2025

MODEL	TOP LINE	NEW LINE	ECO LINE	BROWN LINE	BLACK LINE	GREY LINE	M.U.	Multiple order M.U.
	CODE	CODE	CODE	CODE	CODE	CODE		
TMQ60-EXC	SCD100273	SCD100279	SCD100285	SCD100291	SCD100297	SCD100303	PCS	5
TMQ 72-EXC	SCD100275	SCD100281	SCD100287	SCD100293	SCD100299	SCD100305	PCS	5
TMQ 100-EXC	SCD100277	SCD100283	SCD100289	SCD100295	SCD100301	SCD100307	PCS	3

## KMF



 **MADE IN ITALY**

 **FLEXIBLE SLEEVE KIT FOR EXCELLENS DUCT**

 **KIT MANCHON FLEXIBLE POUR GOULOTTE EXCELLENS**

 **BAUSATZ FLEXIBLE MUFFE FÜR KANAL EXCELLENS**



**AVAILABLE FROM APRIL 2025**

CODE	DESCRIPTION	M.U.	Multiple order M.U.
SCD100566	KMF - FLEXIBLE SLEEVE KIT EXCELLENS MGF 72-EXC WHITE + FLEXIBLE HOSE 70 HOSE PROTECTION - INNER DIAMETER 60 mm	KIT	1
SCD100567	KMF - FLEXIBLE SLEEVE KIT EXCELLENS MgF 72-EXC BLACK + FLEXIBLE HOSE 70 HOSE PROTECTION - INNER DIAMETER 60 mm	KIT	1
SCD100568	KMF - FLEXIBLE SLEEVE KIT EXCELLENS MGF 72-EXC GREY + FLEXIBLE HOSE 70 HOSE PROTECTION - INNER DIAMETER 60 mm	KIT	1
SCD100569	KMF - FLEXIBLE SLEEVE KIT EXCELLENS MGF 100-EXC WHITE + FLEXIBLE HOSE 100 HOSE PROTECTION - INNER DIAMETER 80 mm	KIT	1
SCD100570	KMF - FLEXIBLE SLEEVE KIT EXCELLENS MgF 100-EXC BLACK + FLEXIBLE HOSE 100 HOSE PROTECTION - INNER DIAMETER 80 mm	KIT	1
SCD100571	KMF - FLEXIBLE SLEEVE KIT EXCELLENS MGF 100-EXC GREY + FLEXIBLE HOSE 100 HOSE PROTECTION - INNER DIAMETER 80 mm	KIT	1

## MGF



 **MADE IN ITALY**

 **FLEXIBLE SLEEVE FOR EXCELLENS DUCT**

 **MANCHON DE JONCTION FLEXIBLE POUR GOULOTTE EXCELLENS**

 **FLEXIBLE ANSCHLUSSMUFFE FÜR KANAL EXCELLENS**



**AVAILABLE FROM APRIL 2025**

CODE	DESCRIPTION	M.U.	Multiple order M.U.
SCD100584	MGF - FLEXIBLE SLEEVE FOR EXCELLENS MGF 72-EXC PVC WHITE	PCS	1
SCD100585	MGF - FLEXIBLE SLEEVE FOR EXCELLENS MGF 72-EXC PVC BLACK	PCS	1
SCD100586	MGF - FLEXIBLE SLEEVE FOR EXCELLENS MGF 72-EXC PVC GREY	PCS	1
SCD100587	MGF - FLEXIBLE SLEEVE FOR EXCELLENS MGF 100-EXC PVC WHITE	PCS	1
SCD100588	MGF - FLEXIBLE SLEEVE FOR EXCELLENS MGF 100-EXC BLACK	PCS	1
SCD100589	MGF - FLEXIBLE SLEEVE FOR EXCELLENS MGF 100-EXC PVC GREY	PCS	1

## KRT



**MADE IN ITALY**

 **ROUND TERMINAL KIT WITH FLEXIBLE HOSE AND EXTERNAL FITTING IN ANTI-UV RUBBER**

 **KIT ROSACE ESTHÉTIQUE RONDE AVEC TUBE FLEXIBLE ET RACCORD DE RACCORDEMENT UNITÉ EXTERNE EN CAOUTCHOUC ANTI-UV**

 **RUNDES DESIGN TERMINAL KIT MIT SCHLAUCH UND ANSCHLUSS FÜR AUSSENGERÄT AUS UV-BESTÄNDIGEM GUMMI**

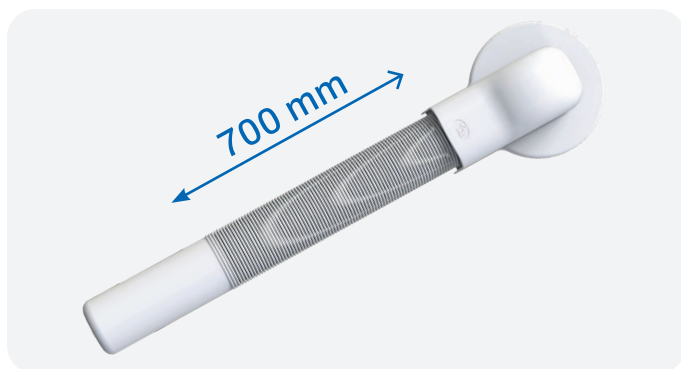

**AVAILABLE FROM APRIL 2025**

CODE	DESCRIPTION	M.U.	 Multiple order M.U.
SCD100551	KRT - ROUND TERMINAL KIT + FLEXIBLE HOSE 70 HOSE PROTECTION - INNER DIAMETER 60mm + EXTERNAL UNIT CONNECTION FITTING IN RUBBER, DIAMETER 60mm - WHITE	KIT	1
SCD100552	KRT - ROUND TERMINAL KIT + FLEXIBLE HOSE 70 HOSE PROTECTION - INNER DIAMETER 60mm + EXTERNAL UNIT CONNECTION FITTING IN RUBBER, DIAMETER 60mm BLACK	KIT	1
SCD100553	KRT - ROUND TERMINAL KIT + FLEXIBLE HOSE 70 HOSE PROTECTION - INNER DIAMETER 60mm + EXTERNAL UNIT CONNECTION FITTING IN RUBBER, DIAMETER 60mm GREY	KIT	1
SCD100557	KRT - ROUND TERMINAL KIT + FLEXIBLE HOSE 100 HOSE PROTECTION - INNER DIAMETER 80mm + EXTERNAL UNIT CONNECTION FITTING IN RUBBER, DIAMETER 80mm - WHITE	KIT	1
SCD100558	KRT - ROUND TERMINAL KIT + FLEXIBLE HOSE 100 HOSE PROTECTION - INNER DIAMETER 80mm + EXTERNAL UNIT CONNECTION FITTING IN RUBBER, DIAMETER 80mm BLACK	KIT	1
SCD100559	KRT - ROUND TERMINAL KIT + FLEXIBLE HOSE 100 HOSE PROTECTION - INNER DIAMETER 80mm + EXTERNAL UNIT CONNECTION FITTING IN RUBBER, DIAMETER 80mm GREY	KIT	1

## RET



**MADE IN ITALY**

 **ROUND TERMINAL FOR FLEXIBLE HOSE Ø 60 / 80 MM**

 **ROSACE ESTHÉTIQUE RONDE POUR TUBE FLEXIBLE Ø 60 / 80 MM**

 **RUNDES DESIGN TERMINAL FÜR SCHLAUCH Ø 60 / 80 MM**

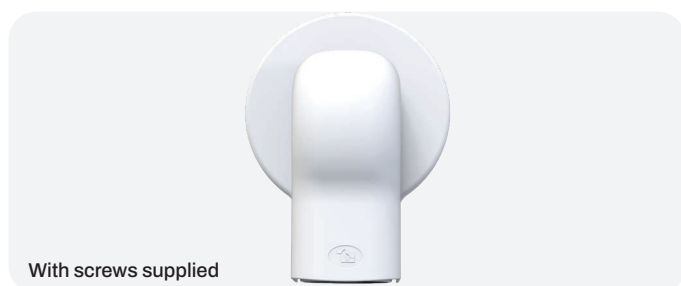

**AVAILABLE FROM APRIL 2025**

CODE	DESCRIPTION	M.U.	 Multiple order M.U.
SCD100575	RET - ROUND TERMINAL FOR FLEXIBLE HOSE 70 HOSE PROTECTION - INNER DIAMETER 60 mm - WHITE	PCS	1
SCD100576	RET - ROUND TERMINAL FOR FLEXIBLE HOSE 70 HOSE PROTECTION - INNER DIAMETER 60 mm BLACK	PCS	1
SCD100577	RET - ROUND TERMINAL FOR FLEXIBLE HOSE 70 HOSE PROTECTION - INNER DIAMETER 60 mm GREY	PCS	1
SCD100581	RET - ROUND TERMINAL FOR FLEXIBLE HOSE 100 HOSE PROTECTION - INNER DIAMETER 80 mm - WHITE	PCS	1
SCD100582	RET - ROUND TERMINAL FOR FLEXIBLE HOSE 100 HOSE PROTECTION - INNER DIAMETER 80 mm BLACK	PCS	1
SCD100583	RET - ROUND TERMINAL FOR FLEXIBLE HOSE 100 HOSE PROTECTION - INNER DIAMETER 80 mm GREY	PCS	1

## KRQ



 **MADE IN ITALY**

 **SQUARE AESTHETIC TERMINAL KIT WITH FLEXIBLE HOSE AND EXTERNAL UNIT CONNECTION FITTING IN ANTI-UV RUBBER**

 **KIT ROSACE ESTHÉTIQUE CARRÉE AVEC TUBE FLEXIBLE ET RACCORD DE RACCORDEMENT UNITÉ EXTERNE EN CAOUTCHOUC ANTI-UV**

 **QUADRATISCHES DESIGN TERMINAL KIT MIT SCHLAUCH UND ANSCHLUSS FÜR AUSSENGERÄT AUS UV-BESTÄNDIGEM GUMMI**

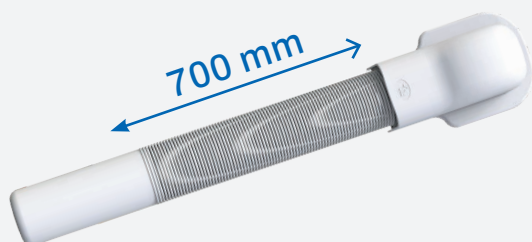

**AVAILABLE FROM APRIL 2025**

CODE	DESCRIPTION	M.U.	 Multiple order M.U.
SCD100548	KRQ - SQUARE TERMINAL KIT + FLEXIBLE HOSE 70 HOSE PROTECTION - INNER DIAMETER 60mm + EXTERNAL UNIT CONNECTION FITTING IN RUBBER, DIAMETER 60mm WHITE	KIT	1
SCD100549	KRQ - SQUARE TERMINAL KIT + FLEXIBLE HOSE 70 HOSE PROTECTION - INNER DIAMETER 60mm + EXTERNAL UNIT CONNECTION FITTING IN RUBBER, DIAMETER 60mm BLACK	KIT	1
SCD100550	KRQ - SQUARE TERMINAL KIT + FLEXIBLE HOSE 70 HOSE PROTECTION - INNER DIAMETER 60mm + EXTERNAL UNIT CONNECTION FITTING IN RUBBER, DIAMETER 60mm GREY	KIT	1
SCD100554	KRQ - SQUARE TERMINAL KIT + FLEXIBLE HOSE 100 HOSE PROTECTION - INNER DIAMETER 80mm + EXTERNAL UNIT CONNECTION FITTING IN RUBBER, DIAMETER 80mm WHITE	KIT	1
SCD100555	KRQ - SQUARE TERMINAL KIT + FLEXIBLE HOSE 100 HOSE PROTECTION - INNER DIAMETER 80mm + EXTERNAL UNIT CONNECTION FITTING IN RUBBER, DIAMETER 80mm BLACK	KIT	1
SCD100556	KRQ - SQUARE TERMINAL KIT + FLEXIBLE HOSE 100 HOSE PROTECTION - INNER DIAMETER 80mm + EXTERNAL UNIT CONNECTION FITTING IN RUBBER, DIAMETER 80mm GREY	KIT	1

## REQ



 **MADE IN ITALY**

 **SQUARE TERMINAL FOR FLEXIBLE HOSE Ø 60 / 80 MM**

 **ROSACE ESTHÉTIQUE CARRÉE POUR TUBE FLEXIBLE Ø 60 / 80 MM**

 **QUADRATISCHES DESIGN TERMINAL FÜR SCHLAUCH Ø 60 / 80 MM**



**AVAILABLE FROM APRIL 2025**

With screws supplied

CODE	DESCRIPTION	M.U.	 Multiple order M.U.
SCD100572	RET - SQUARE TERMINAL FOR FLEXIBLE HOSE 70 HOSE PROTECTION - INNER DIAMETER 60 mm - WHITE	PCS	1
SCD100573	RET - SQUARE TERMINAL FOR FLEXIBLE HOSE 70 HOSE PROTECTION - INNER DIAMETER 60 mm BLACK	PCS	1
SCD100574	RET - SQUARE TERMINAL FOR FLEXIBLE HOSE 70 HOSE PROTECTION - INNER DIAMETER 60 mm GREY	PCS	1
SCD100578	RET - SQUARE TERMINAL FOR FLEXIBLE HOSE 100 HOSE PROTECTION - INNER DIAMETER 80 mm - WHITE	PCS	1
SCD100579	RET - SQUARE TERMINAL FOR FLEXIBLE HOSE 100 HOSE PROTECTION - INNER DIAMETER 80 mm BLACK	PCS	1
SCD100580	RET - SQUARE TERMINAL FOR FLEXIBLE HOSE 100 HOSE PROTECTION - INNER DIAMETER 80 mm GREY	PCS	1

## RCG



MADE IN ITALY

CONNECTION FITTING FOR  
OUTDOOR UNIT IN RUBBER  
Ø 60/80 MM

RACCORD DE  
RACCORDEMENT UNITÉ  
EXTERNE EN CAOUTCHOUC  
Ø 60/80 MM

ANSCHLUSS FÜR  
AUSSENGERÄT AUS GUMMI  
Ø 60/80 MM



[AVAILABLE FROM APRIL 2025](#)

CODE	DESCRIPTION	M.U.	Multiple order M.U.
SCD100602	RCG - CONNECTION FITTING 70 EXTERNAL RUBBER UNIT - INNER DIAMETER 60 mm - WHITE	PCS	1
SCD100603	RCG - CONNECTION FITTING 70 EXTERNAL RUBBER UNIT - INNER DIAMETER 60 mm BLACK	PCS	1
SCD100604	RCG - CONNECTION FITTING 70 EXTERNAL RUBBER UNIT - INNER DIAMETER 60 mm GREY	PCS	1
SCD100605	RCG - CONNECTION FITTING 100 EXTERNAL RUBBER UNIT - INNER DIAMETER 80 mm - WHITE	PCS	1
SCD100606	RCG - CONNECTION FITTING 100 EXTERNAL RUBBER UNIT - INNER DIAMETER 80 mm BLACK	PCS	1
SCD100607	RCG - CONNECTION FITTING 100 EXTERNAL RUBBER UNIT - INNER DIAMETER 80 mm GREY	PCS	1

## TFPT



MADE IN ITALY

FLEXIBLE HOSE PROTECTION  
FOR HOSES

TUBE FLEXIBLE DE  
PROTECTION DES TUBES

SCHUTZSCHLAUCH FÜR  
SCHLÄUCHE



[AVAILABLE FROM APRIL 2025](#)

CODE	DESCRIPTION	DIAMETER PIPE	M.U.	Multiple order M.U.
SCD100596	TFPT - FLEXIBLE HOSE 70 HOSE PROTECTION - INNER DIAMETER 60 mm - 10 meters - WHITE	60	PCS	1
SCD100597	TFPT - FLEXIBLE HOSE 70 HOSE PROTECTION - INNER DIAMETER 60 mm - 10 meters - BLACK	60	PCS	1
SCD100598	TFPT - FLEXIBLE HOSE 70 HOSE PROTECTION - INNER DIAMETER 60 mm - 10 meters - GREY	60	PCS	1
SCD100599	TFPT - FLEXIBLE HOSE 100 HOSE PROTECTION - INNER DIAMETER 80 mm - 10 meters - WHITE	80	PCS	1
SCD100600	TFPT - FLEXIBLE HOSE 100 HOSE PROTECTION - INNER DIAMETER 80 mm - 10 meters - BLACK	80	PCS	1
SCD100601	TFPT - FLEXIBLE HOSE 100 HOSE PROTECTION - INNER DIAMETER 80 mm - 10 meters - GREY	80	PCS	1

**KA**

 **MADE IN ITALY**

 **TEAR-PROOF KIT**

 **KIT ANTI-DÉCHIRURE**

 **REISSFESTE  
WANDDURCHFÜHRUNG**



CODE	DESCRIPTION	M.U.	 Multiple order M.U.
SCD100262	KA TEAR-PROOF KIT WHITE COLOUR WHITE 1000 mm	KIT	1
SCD100263	KA TEAR-PROOF KIT WHITE COLOUR IVORY 1000 mm	KIT	1

**KARFE**

 **MADE IN ITALY**

 **UNIVERSAL  
TEAR-PROOF KIT PLUS FINISH  
FLANGE**

 **KIT UNIVERSEL ANTI-  
DÉCHIRURE PLUS BRIDE  
DE FINITION**

 **REISSFESTE  
WANDDURCHFÜHRUNG MIT  
VEREDELUNGSFLASCH**



CODE	DESCRIPTION	M.U.	 Multiple order M.U.
SCD100264	KARFE UNIVERSAL TEAR-PROOF KIT PLUS FINISH FLANGE WHITE COLOUR L.500	KIT	1



## OPTIMA TMR

MADE IN ITALY

WALL-MOUNTED TERMINAL, ROUND

EXTRÉMITÉ MURALE RONDE

RUNDER WANDABSCHLUSS

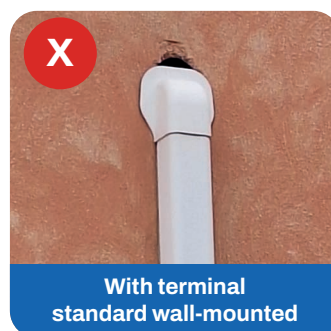
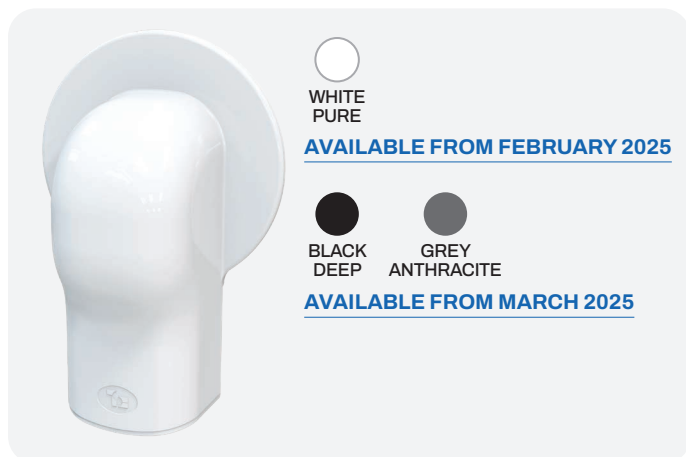

With terminal standard wall-mounted

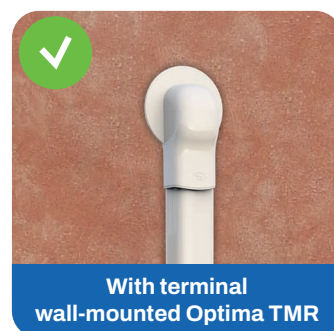

With terminal wall-mounted Optima TMR

THE IDEAL SOLUTION TO COVER UP ERRORS DURING WALL CORING OPERATIONS

Large outer flange with an innovative round shape

MODEL	PURE WHITE	ANTHRACITE GREY	DEEP BLACK	M.U.	Multiple order M.U.
	CODE	CODE	CODE		
TMR 62 - OPT	SCD100244	SCD100252	SCD100265	PCS	5
TMR 75 - OPT	SCD100245	SCD100253	SCD100266	PCS	5
TMR 102 - OPT	SCD100246	SCD100254	SCD100267	PCS	3
TMR 135 - OPT	SCD100247	SCD100255	SCD100268	PCS	3

## OPTIMA TMQ

MADE IN ITALY

WALL-MOUNTED TERMINAL, SQUARE

EXTRÉMITÉ MURALE CARRÉE

QUADRATISCHER WANDABSCHLUSS



WHITE PURE  
AVAILABLE FROM FEBRUARY 2025

BLACK DEEP GREY ANTHRACITE  
AVAILABLE FROM MARCH 2025

MODEL	NEW LINE	ECO LINE	BROWN LINE	BLACK LINE	GREY LINE	M.U.	Multiple order M.U.
	CODE	CODE	CODE	CODE	CODE		
TMQ60-EXC	SCD100279	SCD100285	SCD100291	SCD100297	SCD100303	PCS	5
TMQ 72-EXC	SCD100281	SCD100287	SCD100293	SCD100299	SCD100305	PCS	5
TMQ 100-EXC	SCD100283	SCD100289	SCD100295	SCD100301	SCD100307	PCS	3

## KMGF



 **MADE IN ITALY**

 **FLEXIBLE SLEEVE KIT FOR OPTIMA DUCT**

 **KIT MANCHON FLEXIBLE POUR GOULOTTE OPTIMA**

 **BAUSATZ FLEXIBLE MUFFE FÜR KANAL OPTIMA**



 **NEW LINE**  
  **BLACK LINE**  
  **GREY LINE**

**AVAILABLE FROM APRIL 2025**

CODE	DESCRIPTION	M.U.	 Multiple order M.U.
SCD100560	KIT OPTIMA FLEXIBLE SLEEVE MGF 75-OPT WHITE + FLEX DIAMETER 60	KIT	1
SCD100561	KIT FLEXIBLE SLEEVE OPTIMA MGF 75-OPT BLACK + FLEX DIAMETER 60	KIT	1
SCD100562	KIT FLEXIBLE SLEEVE OPTIMA MGF 75-OPT GREY + FLEX DIAMETER 60	KIT	1
SCD100563	KIT OPTIMA FLEXIBLE SLEEVE MGF 102-OPT WHITE + FLEX DIAMETER 80	KIT	1
SCD100564	KIT FLEXIBLE SLEEVE OPTIMA MGF 102-OPT BLACK + FLEX DIAMETER 80	KIT	1
SCD100565	KIT FLEXIBLE SLEEVE OPTIMA MGF 102-OPT GREY + FLEX DIAMETER 80	KIT	1

## MGFO



 **MADE IN ITALY**

 **FLEXIBLE SLEEVE FOR OPTIMA DUCT**

 **MANCHON DE JONCTION FLEXIBLE POUR GOULOTTE OPTIMA**

 **FLEXIBLE ANSCHLUSSMUFFE FÜR KANAL OPTIMA**



 **NEW LINE**  
  **BLACK LINE**  
  **GREY LINE**

**AVAILABLE FROM APRIL 2025**

CODE	DESCRIPTION	M.U.	 Multiple order M.U.
SCD100590	OPTIMA FLEXIBLE SLEEVE MGF 75-OPT PVC WHITE	PCS	1
SCD100591	OPTIMA FLEXIBLE SLEEVE MGF 75-OPT PVC BLACK	PCS	1
SCD100592	OPTIMA FLEXIBLE SLEEVE MGF 75-OPT PVC GREY	PCS	1
SCD100593	OPTIMA FLEXIBLE SLEEVE MGF 102-OPT PVC WHITE	PCS	1
SCD100594	OPTIMA FLEXIBLE SLEEVE MGF 102-OPT PVC BLACK	PCS	1
SCD100595	OPTIMA FLEXIBLE SLEEVE MGF 102-OPT PVC GREY	PCS	1

## FLEXIBLE SLEEVE KIT INSTALLATION EXAMPLE



**KMF sleeve kit for Excellens trunking**



**KMGF sleeve kit for Optima trunking**



**Obstacle passage example with KMGF optima sleeve kit**

## AESTHETIC FLANGE INSTALLATION EXAMPLE



**1**  
Fix the rear part of the aesthetic flange in correspondence with the wall hole



**2**  
Insert the refrigeration lines and the power cable into the wall hole

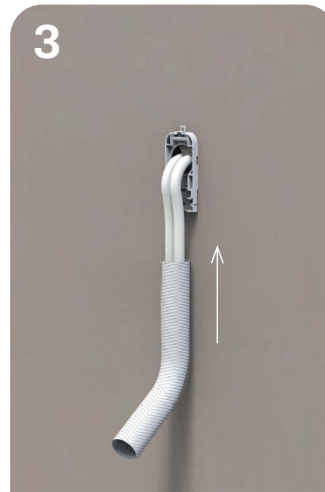

**3**  
Place the refrigeration pipes and the power supply in the corrugated protection pipe



**4**  
Fix the corrugated tube to the rear part of the aesthetic flange using the bracket provided

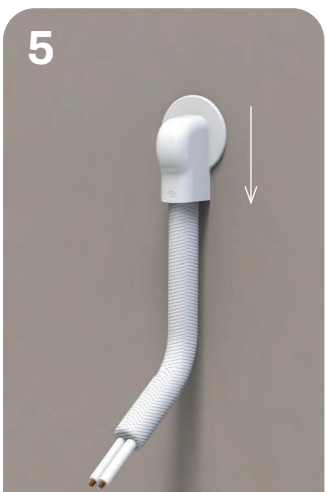

**5**  
Fit the terminal and slide it down then secure



**6**  
Feed the rubber sleeve totally into the corrugated pipe



**7**  
Flare the refrigerant pipes and fix them to the taps of the outdoor unit, connect the power supply. Approach and position the rubber sleeve near the taps.

# PROFESSIONAL FAN COIL

## VERTICAL BUILT-IN INSTALLATION BOX FOR FAN COILS WITH BUILT-IN INSPECTABLE SIPHON



 **MADE IN ITALY**

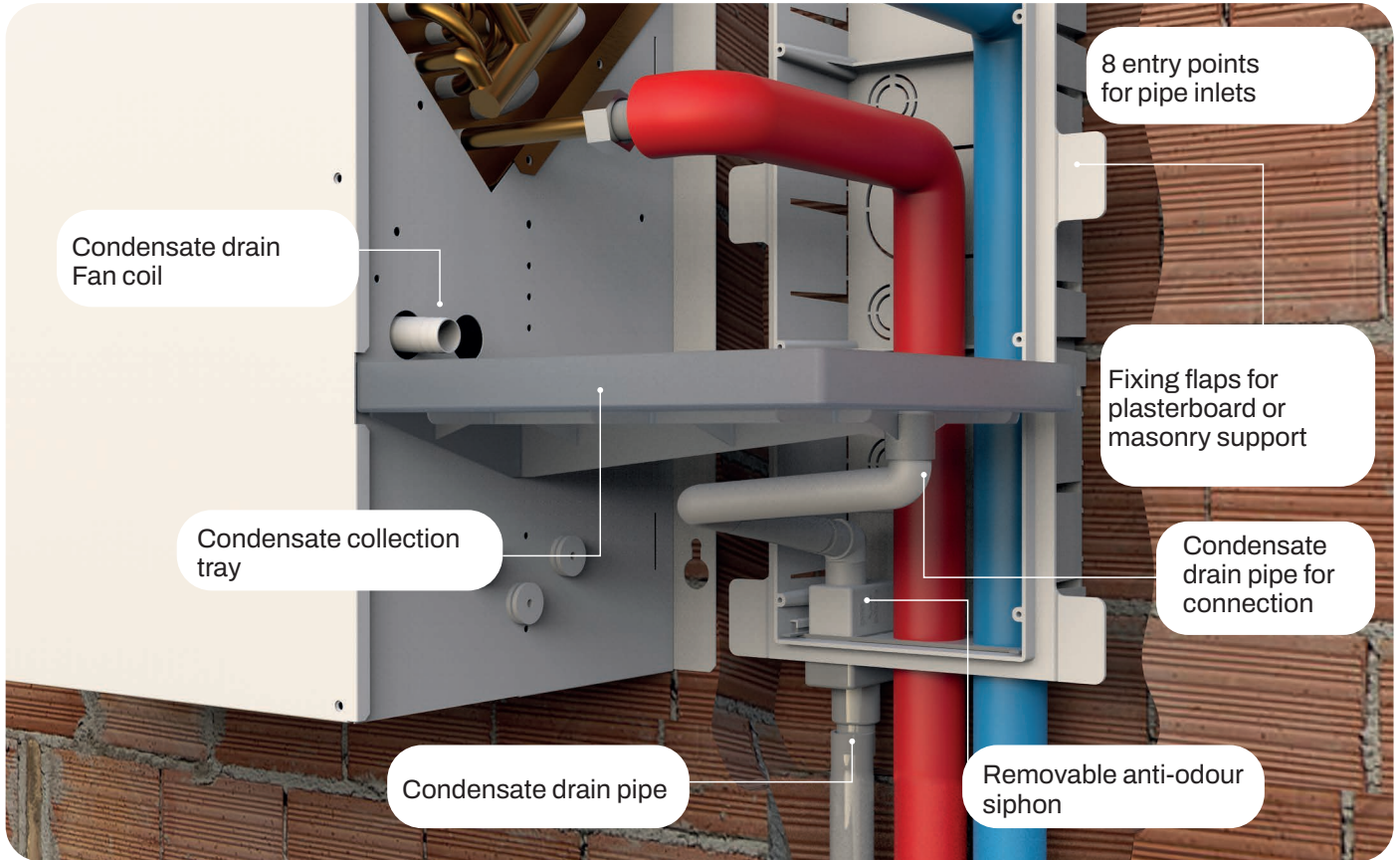

# PROFESSIONAL FAN COIL



 **MADE IN ITALY**

 **VERTICAL BUILT-IN INSTALLATION BOX FOR FAN COILS WITH BUILT-IN INSPECTABLE SIPHON**

 **BOÎTIER VERTICAL DE PRÉDISPOSITION POUR VENTIL-CONVECTEUR AVEC SIPHON CONTRÔLABLE INTÉGRÉ**

 **VERTIKALE INSTALLATIONSBOX FÜR GEBLÄSEKONVEKTOR MIT INTEGRIERTEM INSPIZIERBAREM SIPHON**

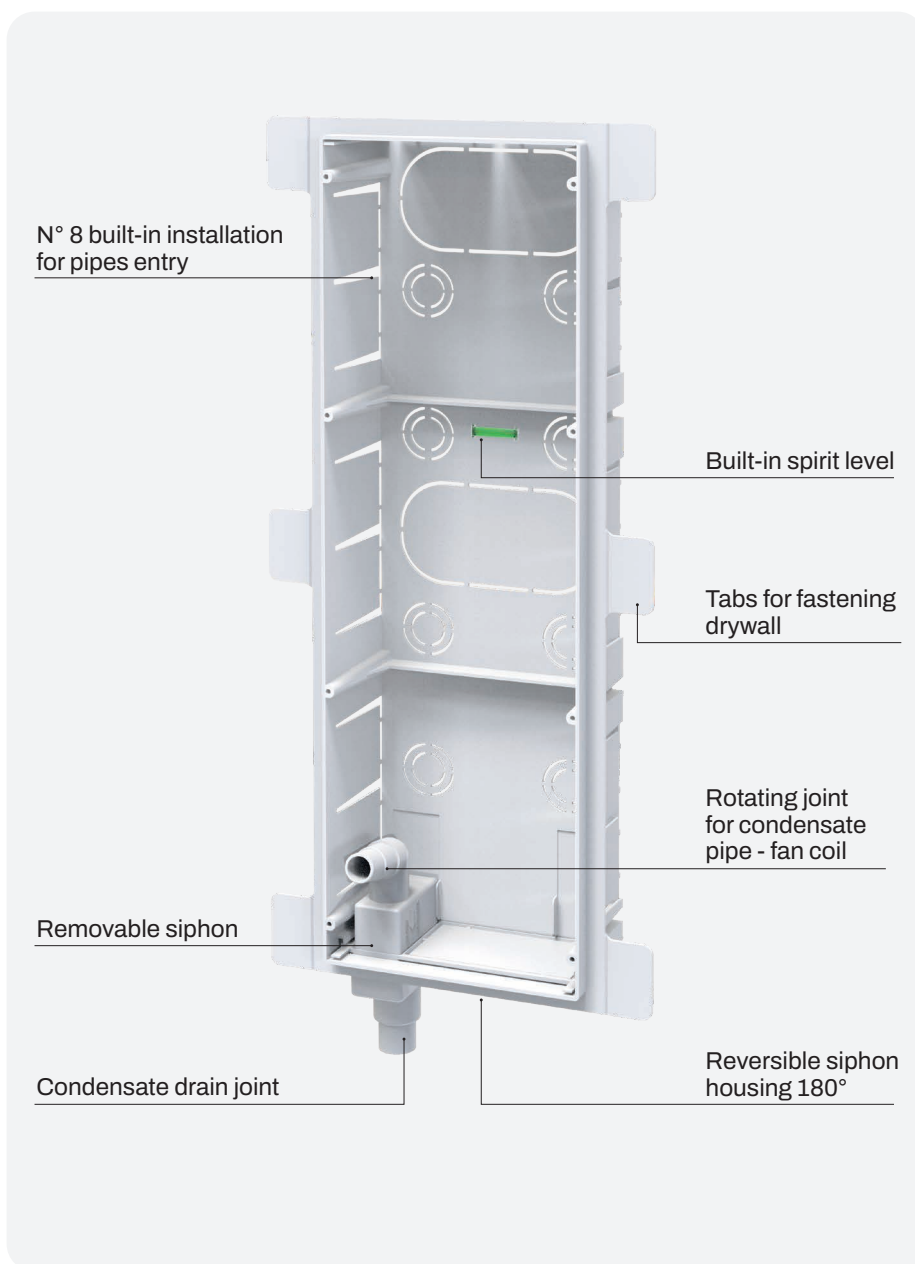

## Supplied accessories



**AVAILABLE FROM APRIL 2025**

CODE	DESCRIPTION	M.U.	 Multiple order M.U.
SCD200013	VERTICAL ARRANGEMENT WITH FAN-COIL SIPHON	PCS	1

 **CONDENSATE DRAIN PIPE Ø 18 DOUBLE LAYER - SLEEVES Ø 16/18**

 **TUYAU DE DRAINAGE DU CONDENSAT Ø 18 DOUBLE REVÊTEMENT - MANCHONS Ø 16/18**

 **KONDENSATABLAUFROHR Ø 18 MIT DOPPELTER ISOLIERUNG - MUFFEN Ø 16/18**



  **MADE IN ITALY**

**WITHOUT PACKAGING**

AVAILABLE FROM MARCH 2025

CODE	DESCRIPTION	LENGTH	M.U.	 Multiple order M.U.
SCD300095	CONDENSATE DRAIN PIPE Ø 18 DOUBLE LAYER - SLEEVES Ø 16/18	50 m ROLL	PCS	1

 **CONDENSATE DRAIN PIPE Ø 20 DOUBLE LAYER - SLEEVES Ø 18/20**

 **TUYAU DE DRAINAGE DU CONDENSAT Ø 20 DOUBLE REVÊTEMENT - MANCHONS Ø 18/20**

 **KONDENSATABLAUFROHR Ø 20 MIT DOPPELTER ISOLIERUNG - MUFFEN Ø 18/20**



  **MADE IN ITALY**

AVAILABLE FROM MARCH 2025

CODE	DESCRIPTION	LENGTH	M.U.	 Multiple order M.U.
SCD300097	CONDENSATE DRAIN PIPE Ø 20 DOUBLE LAYER - SLEEVES Ø 18/20	50 m ROLL	PCS	1

 **CONDENSATE DISCHARGE PIPE Ø 20 WITH DOUBLE LAYER - SLEEVES Ø 16/18 AND Ø 18/20, ALTERNATED**

 **TUYAU D'ÉVACUATION DES CONDENSATS Ø 20 À DOUBLE REVÊTEMENT - MANCHONS Ø 16/18 ET Ø 18/20 ALTERNÉS**

 **KONDENSATABLAUFLEITUNG Ø 20 MIT DOPPELTER BESCHICHTUNG - MUFFEN Ø 16/18 UND Ø 18/20 IM WECHSEL**



  **MADE IN ITALY**

CODE	DESCRIPTION	LENGTH	M.U.	 Multiple order M.U.
SCD300086	CONDENSATE DISCHARGE PIPE Ø 20 WITH DOUBLE LAYER - SLEEVES Ø 16/18 AND Ø 18/20, ALTERNATED	50 m ROLL	PCS	1

 **CONDENSATE DRAIN PIPE Ø 18 SINGLE LAYER - SLEEVES Ø 16/18**

 **TUYAU DE DRAINAGE DU CONDENSAT Ø 18 SIMPLE REVÊTEMENT - MANCHONS Ø 16/18**

 **KONDENSATABLAUFROHR Ø 18 EINFACHBESCHICHTUNG - MUFFEN Ø 16/18**



  **MADE IN ITALY**

**WITHOUT PACKAGING**

**AVAILABLE FROM MARCH 2025**

CODE	DESCRIPTION	LENGTH	M.U.	 Multiple order M.U.
SCD300096	CONDENSATE DRAIN PIPE Ø 18 SINGLE LAYER - SLEEVES Ø 16/18	50 m ROLL	PCS	1

 **CONDENSATE DRAIN PIPE Ø 20 DOUBLE LAYER - SLEEVES Ø 18/20**

 **TUYAU DE DRAINAGE DU CONDENSAT Ø 20 DOUBLE REVÊTEMENT - MANCHONS Ø 18/20**

 **KONDENSATABLAUFROHR Ø 20 MIT DOPPELTER ISOLIERUNG - MUFFEN Ø 18/20**



  **MADE IN ITALY**

CODE	DESCRIPTION	LENGTH	M.U.	 Multiple order M.U.
SCD300087	CONDENSATE DRAIN PIPE Ø 18 SINGLE LAYER - SLEEVES Ø 16/18	50 m ROLL	PCS	1

 **CONDENSATE DRAIN PIPE Ø 20 SINGLE GRAY LAYER - SLEEVES Ø 18/20**

 **TUYAU DE DRAINAGE DU CONDENSAT Ø 20 SIMPLE GRIS REVÊTEMENT - MANCHONS Ø 18/20**

 **KONDENSATABLAUFROHR Ø 20 EINFACHBESCHICHTUNG - MUFFEN Ø 18/20**





  **MADE IN ITALY**

**WITHOUT PACKAGING**

**AVAILABLE FROM MARCH 2025**

CODE	DESCRIPTION	LENGTH	M.U.	 Multiple order M.U.
SCD300096	CONDENSATE DRAIN PIPE Ø 20 SINGLE GRAY LAYER - SLEEVES Ø 18/20	50 m ROLL	PCS	1

 **BLUE CONDENSATE DRAIN PIPE REINFORCED BY UNDER-TRACK Ø 20 SINGLE LAYER - SLEEVES Ø 18/20**

 **TUYAU DE DRAINAGE DU CONDENSAT BLEU RENFORCÉ POUR ENCASTREMENT Ø 20 MONOCOUCHE - MANCHONS Ø 18/20**

 **HELLBLAUE KONDENSATABLEITUNG VERSTÄRKT FÜR UNTERFLURVERLEGUNG MIT Ø 20 EINFACHBESCHICHTUNG - MUFFEN Ø 18/20**



 **MADE IN ITALY**

**WITHOUT PACKAGING**

**AVAILABLE FROM MARCH 2025**

CODE	DESCRIPTION	LENGTH	M.U.	 Multiple order M.U.
SCD300094	BLUE CONDENSATE DRAIN PIPE REINFORCED BY UNDER-TRACK Ø 20 SINGLE LAYER - SLEEVES Ø 18/20	50 m ROLL	PCS	1

 **30 M COILED PVC CONDENSATE DRAIN PIPE FOR DUCT INSTALLATION**

 **TUYAU DE DRAINAGE DU CONDENSAT EN PVC ENROULÉ DE 30 M POUR INSTALLATION DANS GOULOTTE**

 **30 M SPIRALFÖRMIGE PVC-KONDENSATABLEITUNG FÜR ZUM EINBAU IN KANÄLEN**



 **MADE IN ITALY**

**AVAILABLE FROM MARCH 2025**

CODE	DESCRIPTION	LENGTH	M.U.	 Pieces per box
SCD300098	30 M COILED PVC CONDENSATE DRAIN PIPE FOR DUCT INSTALLATION Ø 16	30m ROLL	PCS	1
SCD300099	30 M COILED PVC CONDENSATE DRAIN PIPE FOR DUCT INSTALLATION Ø 20	30m ROLL	PCS	1



## EMPIRE EVO 600

 **FLOOR STAND**
 **SUPPORT AU SOL**
 **BODENHALTERUNG**

CODE	DESCRIPTION	M.U.	 Pieces per box
SCD500453	FLOOR STAND "EMPIRE EVO" L 1300XP600 - IVORY	PCS	1
SCD500454	FLOOR STAND "EMPIRE EVO" L 1300XP600 - GREY	PCS	1

## EMPIRE EVO

 **FLOOR STAND**
 **SUPPORT AU SOL**
 **BODENHALTERUNG**

CODE	DESCRIPTION	M.U.	 Pieces per box
SCD500437	FLOOR STAND "EMPIRE EVO 480" - BLACK	PCS	1
SCD500438	FLOOR STAND "EMPIRE EVO 550" - BLACK	PCS	1
SCD500272	FLOOR STAND "EMPIRE EVO 440" - ANTHRACITE GREY RAL 7016	PCS	1
SCD500273	FLOOR STAND "EMPIRE EVO 480" - ANTHRACITE GREY RAL 7016	PCS	1
SCD500274	FLOOR STAND "EMPIRE EVO 550" - ANTHRACITE GREY RAL 7016	PCS	1



## TÜV CERTIFICATION FOR OUTDOOR UNIT BRACKETS: GUARANTEE OF SAFETY AND QUALITY.

Choosing TÜV-certified brackets from Tecnosystemi means prioritizing **quality**, **safety**, and long-term **reliability**.



High Durability



Guarantee



Control and Quality



Certificate

CERTIFICAT • CERTIFICADO • CERTIFIKAT • CERTIFICATE • CERTIFICAZIONE • CERTIFICAZIONE

# CERTIFICATE

No. Z1 129005 0001 Rev. 00

Holder of Certificate:

Techrosystemi S.p.a. Società Benefit  
Via Cavour 24  
20128 Milano (MI) Italy

Certification Mark:



Product:

Wall bracket  
(Conditioning system carrier arms)

This product was found in a laboratory, tested and compared with the product specifications. The certification mark and the number can be affixed to the product. It is not permitted to use the mark for other products. The manufacturer is responsible for the product. The manufacturer must ensure that the product meets the requirements of the product specification. The manufacturer must ensure that the product meets the requirements of the product specification. The manufacturer must ensure that the product meets the requirements of the product specification.

Test report no.:

12228402/04/00000002

Video ref.:

20241124

Date:

2024/11/24

## ZEUS HIGH ARTICULATED



 MADE IN ITALY

 ANTI-VIBRATION FOOT IN VULCANISED RUBBER SBR

 PIED ANTIVIBRATOIRE EN CAOUTCHOUC VULCANISÉ SBR

 SCHWINGUNGSDÄMPFENDER FUSS AUS VULKANISIERTEM GUMMI SBR



**ZEUS**  
HIGH ARTICULATED

PACK 6 PZ

CODE	DESCRIPTION	MOD.	WEIGHT CAPACITY [kg]	M.U.	 Pieces per box
SCD500351	VULCANIZED RUBBER FLOOR SUPPORT - ADJUSTABLE AND ARTICULATED - "ZEUS" H.100 LONG (PACK OF 6 PCS)	LONG	500	pcs	6

## TS-COVER SILENT WALL

 MADE IN ITALY

 AESTHETIC SOUNDPROOF PROTECTION FOR EXTERNAL WALL-MOUNTED UNITS

 PROTECTION ESTHÉTIQUE INSONORISÉE POUR UNITÉS EXTERNES MURALES

 SCHALLGEDÄMMTE DESIGN-SCHUTZABDECKUNG FÜR WANDMONTAGE AUSSENGERÄTE



Noise reduction up to 9,4 dB(A)

CODE	DESCRIPTION	COLOUR	M.U.	 Multiple order M.U.
SCD500446	TS-COVER SILENT WALL - IVORY	IVORY RAL 9002	PCS	1
SCD500447	TS-COVER SILENT WALL - GREY	ANTHRACITE GREY RAL 7016	PCS	1

## TS-COVER SILENT FLOOR

  
 MADE IN ITALY

**AESTHETIC SOUNDPROOF  
PROTECTION FOR EXTERNAL  
FLOOR-MOUNTED UNITS**

**PROTECTION ESTHÉTIQUE  
INSONORISÉE POUR UNITÉS  
EXTERNES AU SOL**

**SCHALLGEDÄMMTE DESIGN-  
SCHUTZABDECKUNG  
FÜR BODENMONTIERTE  
AUSSENGERÄTE**



**Noise reduction  
up to 9,4 dB(A)**

CODE	DESCRIPTION	COLOUR	M.U.	 Multiple order M.U.
SCD500448	TS-COVER SILENT FLOOR - IVORY	IVORY RAL 9002	PCS	1
SCD500449	TS-COVER SILENT FLOOR - GREY	ANTHRACITE GREY RAL 7016	PCS	1

## TS-COVER SILENT BOX



  
 MADE IN ITALY



**AESTHETIC SOUNDPROOF  
PROTECTION FOR EXTERNAL  
FREE-STANDING UNITS**

**PROTECTION ESTHÉTIQUE  
INSONORISÉE POUR UNITÉS  
EXTERNES EN ÎLOT**

**SCHALLGEDÄMMTE DESIGN-  
SCHUTZABDECKUNG  
FÜR FREILIEGENDE  
AUSSENGERÄTE**



**Noise reduction  
up to 13,3 dB(A)**

CODE	DESCRIPTION	COLOUR	M.U.	 Multiple order M.U.
SCD500450	TS-COVER SILENT BOX - IVORY	IVORY RAL 9002	PCS	1
SCD500451	TS-COVER SILENT BOX - GREY	ANTHRACITE GREY RAL 7016	PCS	1

 **INSULATED DISTRIBUTION PLENUM H 160 FOR CMV FOR FLEXIBLE DUCTED HOSE 6-8 OUTPUTS Ø 75 E Ø 90 WITH SLEEVES COMPLETE WITH CALIBRATION DAMPER WITH ADJUSTMENT**

 **PLÉNUM ISOLÉ DE DISTRIBUTION H 160 POUR VMC POUR TUBE FLEXIBLE CANALISÉ 6-8 SORTIES Ø 75 ET Ø 90 AVEC MANCHONS DOTÉS DE REGISTRE RÉGLABLE**

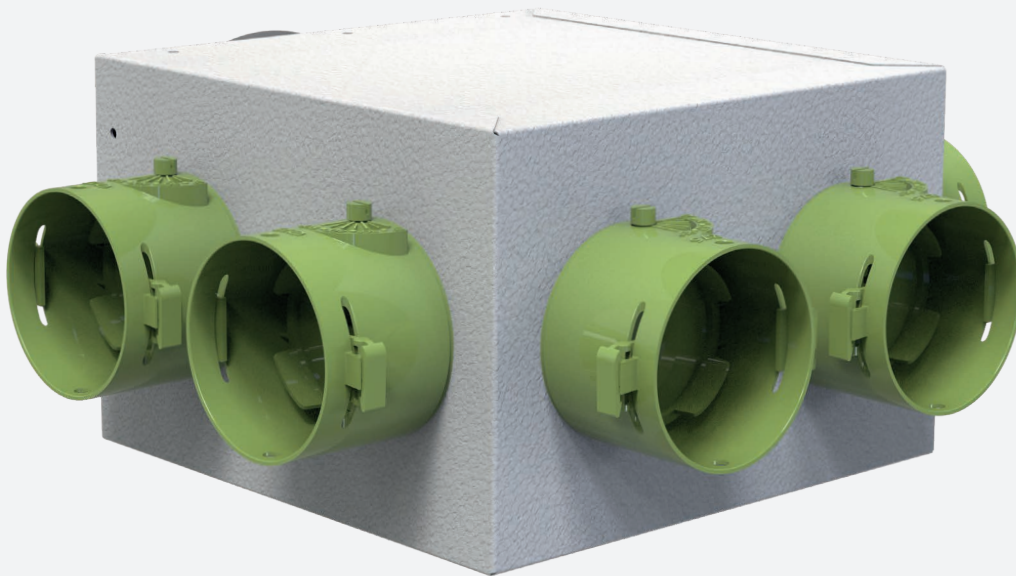
 **ISOLIERTES VERTEILER-PLENUM H 160 FÜR VMC FÜR KANALISIERTEN SCHLAUCH 6-8 AUSGÄNGE Ø 75 UND Ø 90 MIT MUFFEN, KOMPLETT MIT STELSCHIEBER MIT REGULIERUNG**



*Example plenum 8 outputs*

CODE	DESCRIPTION	M.U.	 Multiple order M.U.
ACD600158	DISTRIBUTION PLENUM IN INSULATED SHEET METAL 6 OUTLETS Ø75 WITH INLET Ø150	PCS	1
ACD600159	DISTRIBUTION PLENUM IN INSULATED SHEET METAL 8 OUTLETS Ø75 WITH INLET Ø150	PCS	1
ACD600160	DISTRIBUTION PLENUM IN INSULATED SHEET METAL 6 OUTLETS Ø90 WITH INLET Ø150	PCS	1
ACD600161	DISTRIBUTION PLENUM IN INSULATED SHEET METAL 8 OUTLETS Ø90 WITH INLET Ø150	PCS	1

# TS-HRVU

MADE IN ITALY

 VENTILATION UNIT WITH HEAT RECOVERY 
  UNITÉ DE VENTILATION AVEC RÉCUPÉRATION DE CHALEUR 
  LÜFTUNGSEINHEIT MIT WÄRMERÜCKGEWINNUNG

**A**

From 120 to 500 m<sup>3</sup>/h

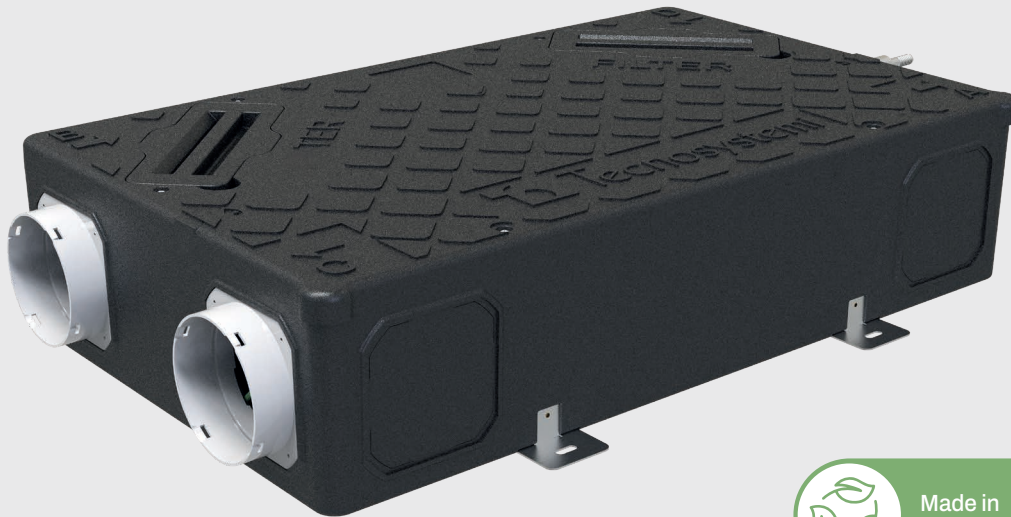

Made in RECYCLED EPP (PPE)

AVAILABLE FROM FEBRUARY 2025

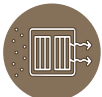

Extractable ISO Coarse filters 60% G4



Modbus BMS connection



Thermo-acoustic insulation



Brushless EC motors



Antifreeze feature



Reversible upon assembly



90° adjustable aeraulic connections



4 temperature sensors



Free Cooling Free Heating

CODE	DESCRIPTION	M.U.	 Multiple order M.U.
ACD200068	HRVU HEAT RECOVERY UNIT TS120 0/10V	PCS	1
ACD200067	HRVU TS180 RF HEAT RECOVERY UNIT	PCS	1
ACD200066	HRVU TS250 RF HEAT RECOVERY UNIT	PCS	1
ACD200075	HRVU TS320 RF HEAT RECOVERY UNIT	PCS	1
ACD200072	HRVU TS380 RF HEAT RECOVERY UNIT	PCS	1
ACD200073	HRVU TS500 RF HEAT RECOVERY UNIT	PCS	1
ACD200069	CONTROL FOR CMV DISPLAY WITH PROGRAMMING	PCS	1
ACD200070	CLOSING PLATE FOR CONTROLS BOX503	PCS	1
ACD200071	FILTER F7 ISO EMP >50% FOR MOD. 120-180-250-320 M3H PLEATED	PCS	1
ACD200074	FILTER F7 ISO EPM1 >50% FOR MOD. 380-500 M3H PLEATED	PCS	1

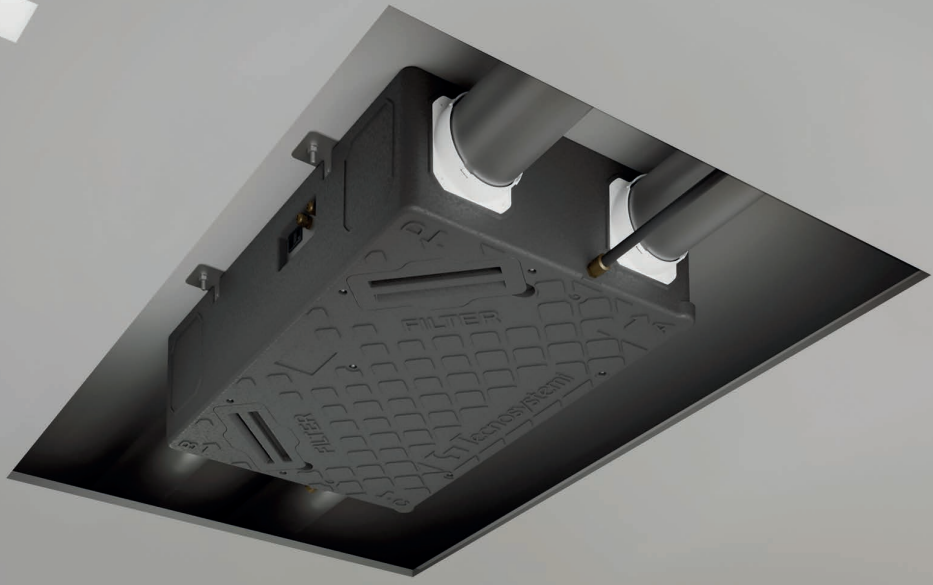



# MINI-LED ASTRA

 **MADE IN ITALY**

 **WALL-MOUNTED TOUCH THERMOSTAT IN RADIO FREQUENCY WITH BATTERIES**

 **THERMOSTAT TACTILE MURAL À FRÉQUENCE RADIO AVEC PILES**

 **WANDMONTIERTER TOUCH-THERMOSTAT IN HOCHFREQUENZ MIT BATTERIEN**

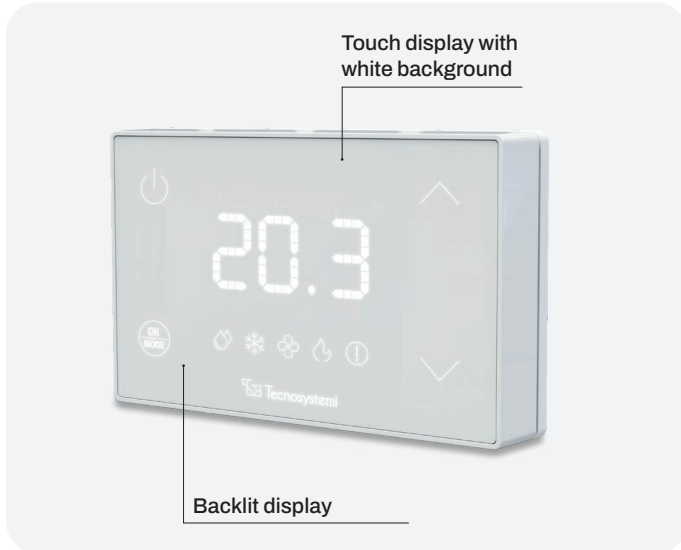

CODE	DESCRIPTION	M.U.	 Multiple order M.U.
GAD100016	MINI-LED WALL-MOUNTED TOUCH THERMOSTAT ASTRA	PCS	1

# PRO AIR PACK RF 2-3-4-5-6 ZONES WITH MINI-LED ASTRA



 MADE IN ITALY



## KIT RAPID WITH PLENUM AND PLASTIC GRILLS ANTICONDENSATION WITH ADJUSTABLE FLAPS WITH CONNECTIONS Ø 125

Pag. 87

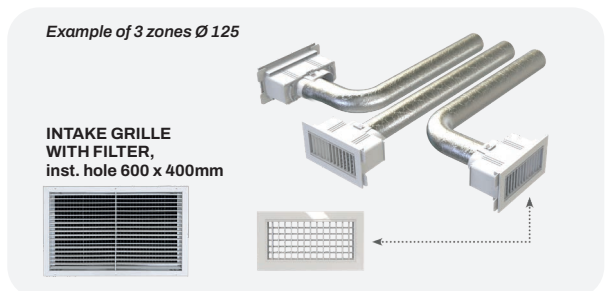

## KIT RAPID WITH PLENUM AND PLASTIC GRILLS ANTICONDENSATION WITH ADJUSTABLE FLAPS WITH CONNECTIONS Ø 150

Pag. 88-89

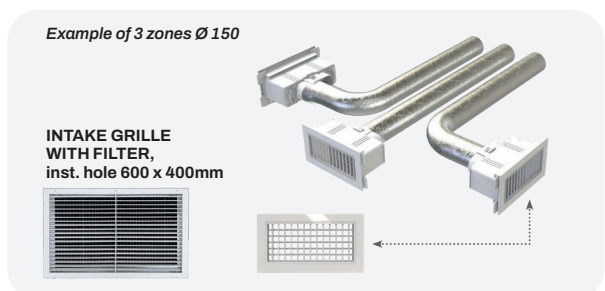

## KIT RAPID WITH PLENUM AND PLASTIC GRILLS ANTICONDENSATION WITH ADJUSTABLE FLAPS WITH CONNECTIONS Ø 200

Pag. 90-91

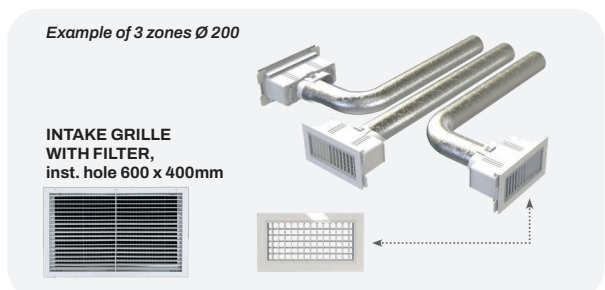

# BPAP



MADE IN ITALY

 **INTAKE AND SUPPLY GRILLE IN ANTI-CONDENSATION ABS PLASTIC, WHITE**

 **GRILLE DE REFOULEMENT ET DE RÉCUPÉRATION EN PLASTIQUE ABS BLANC ANTI-CONDENSATION**

 **ZULUFT- UND RÜCKLAUFGITTER AUS WEISSEM ABS-KUNSTSTOFF MIT KONDENSATSCHUTZ**

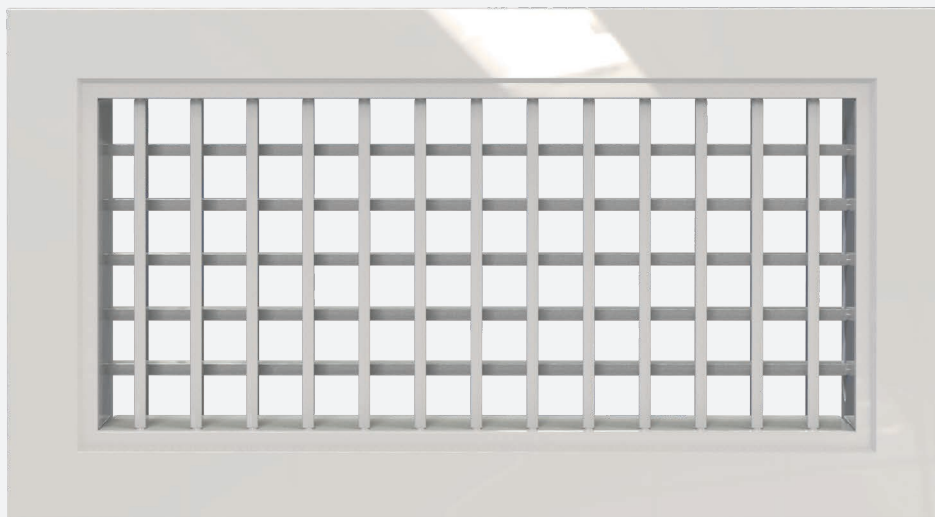
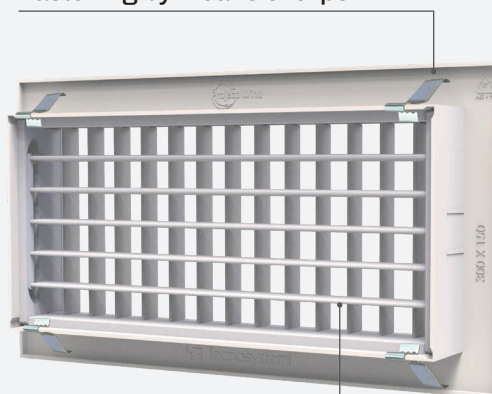



Image refers to model PWD100015

Fastening by means of clips



Adjustable flaps

**AVAILABLE FROM JUNE 2025**

CODE	DESCRIPTION	DIM. EXTERNAL FRAME [mm]	REAR NECK DIMENSIONS [mm]	DIM. INSTALLATION HOLE [mm]	PROFILE OF REAR NECK [mm]	M.U.	 Multiple order M.U.
PWD100018	GRILLE IN ABS - 400 x 150	433 x 183	385 x 135	400 x 150	41	PCS	1
PWD100024	GRILLE IN ABS - 500 x 150	533 x 183	500 x 150	485 x 135	41	PCS	1

# WALL BOX



**MADE IN ITALY**

 **TELESCOPIC PLENUM IN WHITE ANTI-CONDENSATION POLYSTYRENE PLASTIC**

 **PLÉNUM TÉLESCOPIQUE EN PLASTIQUE POLYSTYRÈNE BLANC ANTI-CONDENSATION**

 **TELESKOPISCHES PLENUM AUS WEISSEM PS-KUNSTSTOFF MIT KONDENSATSCHUTZ**

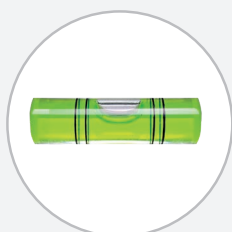
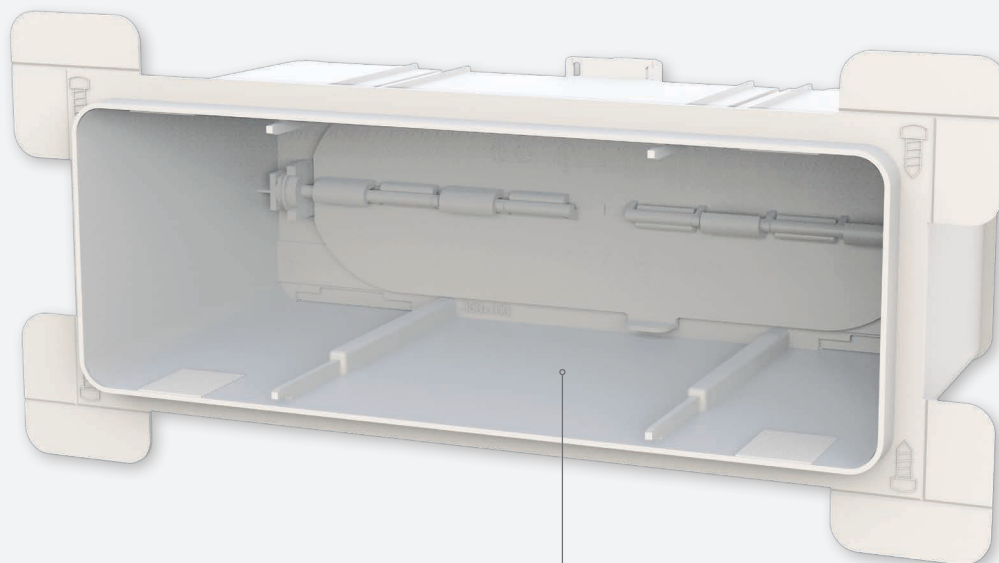

Spirit level supplied for models with a depth of 150 to 200

## Wall Box

CODE	DESCRIPTION	M.U.	 Multiple order M.U.
PWD402430	PLENUM IN PS WITH TELESCOPIC REAR COLLAR FOR 200X100 GRILLE	PCS	1
PWD402431	PLENUM IN PS WITH TELESCOPIC REAR COLLAR FOR 300X100 GRILLE	PCS	1
PWD402432	PLENUM IN PS WITH TELESCOPIC REAR COLLAR FOR 400X100 GRILLE	PCS	1
PWD402433	PLENUM IN PS WITH TELESCOPIC REAR COLLAR FOR 300X150 GRILLE	PCS	1
PWD402434	PLENUM IN PS WITH TELESCOPIC REAR COLLAR FOR 400X150 GRILLE	PCS	1
*PWD402440	PLENUM IN PS WITH TELESCOPIC REAR COLLAR FOR 500X150 GRILLE	PCS	1
*PWD402441	PLENUM IN PS WITH TELESCOPIC REAR COLLAR FOR 500X200 GRILLE	PCS	1
ACD600091	CMV BOX BRACKET KIT	KIT	1

**AVAILABLE FROM FEBRUARY 2025**

**\*AVAILABLE FROM JUNE 2025**

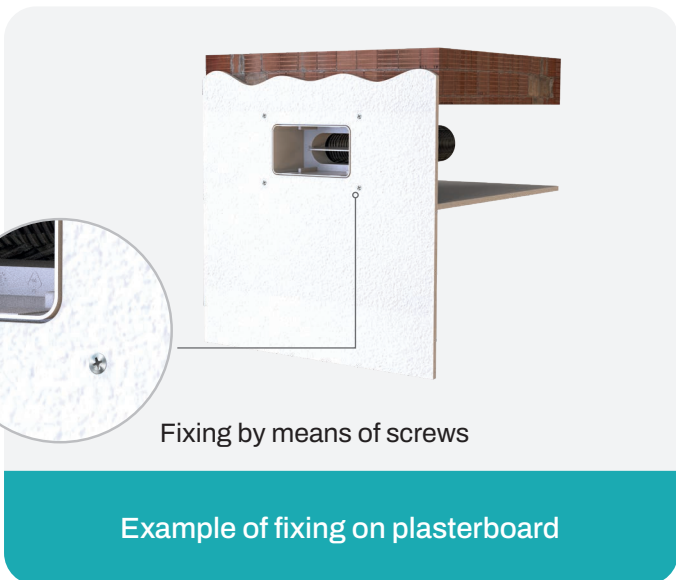
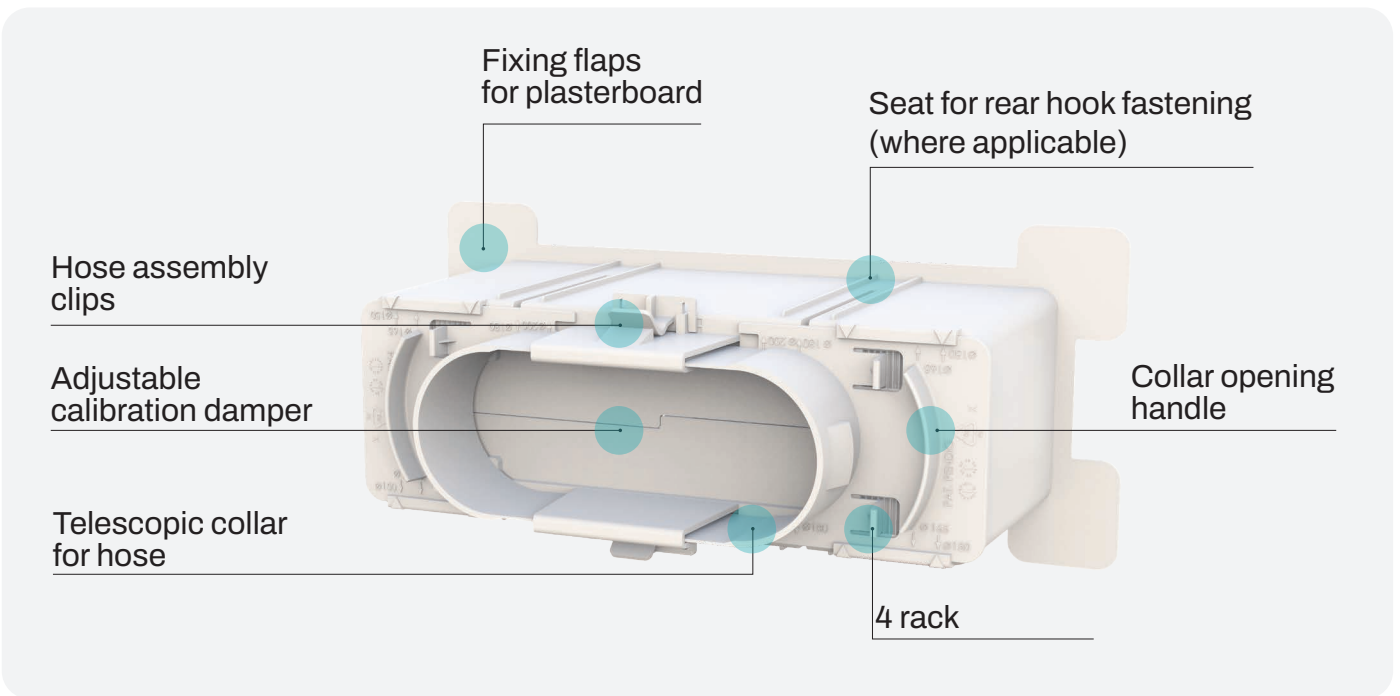

# LINEAR DELIVERY DIFFUSERS IN ANTI-CONDENSATE PVC PLASTIC AND ALUMINIUM

AVAILABLE FROM FEBRAURY 2025

 LINEAR DELIVERY DIFFUSERS  
IN ANTI-CONDENSATE PVC  
PLASTIC WITH DAMPER  
1-2-3-4 SLOTS

 DIFFUSEUR LINÉAIRE DE  
REFOULEMENT EN PLASTIQUE  
PVC ANTI-CONDENSATION  
AVEC REGISTRE  
À 1-2-3-4 FENTES

 LINEARER ZULUFT-  
DIFFUSOR AUS PVC MIT  
KONDENSATSCHUTZ MIT  
SCHIEBER - 1-2-3-4 SCHLITZE

 LINEAR DELIVERY DIFFUSERS  
IN ALUMINIUM WITH DAMPER  
1-2-3-4 SLOTS

 DIFFUSEUR LINÉAIRE DE  
REFOULEMENT EN ALUMINIUM  
AVEC REGISTRE  
À 1-2-3-4 FENTES

 LINEARER ZULUFT-DIFFUSOR  
AUS ALUMINIUM MIT  
SCHIEBER - 1-2-3-4 SCHLITZE

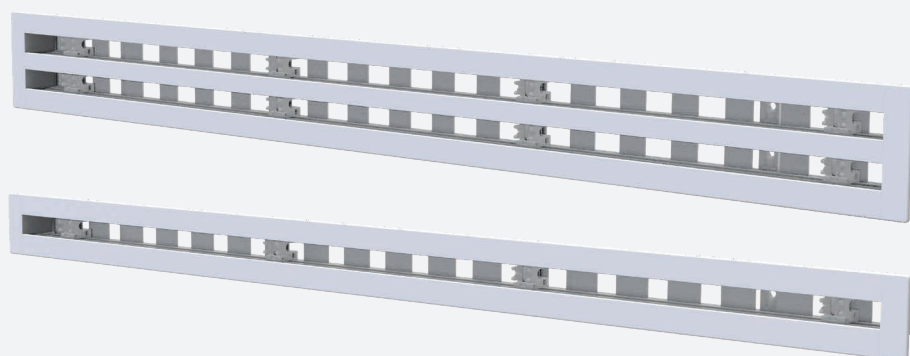



  
MATT  
WHITE

 **LINEAR DELIVERY DIFFUSERS  
IN ANTI-CONDENSATE PVC  
PLASTIC WITH DAMPER  
AND CENTRAL BAFFLE**  
1-2-3-4 SLOTS

 **DIFFUSEUR LINÉAIRE DE  
REFOULEMENT EN PLASTIQUE  
PVC ANTI-CONDENSATION  
AVEC REGISTRE ET  
DÉFLECTEUR CENTRAL**  
À 1-2-3-4 FENTES

 **LINEARER ZULUFT-  
DIFFUSOR AUS PVC MIT  
KONDENSATSCHUTZ  
MIT SCHIEBER UND  
ZENTRALER STÖRKLAPPE -**  
1-2-3-4 SCHLITZE

 **LINEAR DELIVERY DIFFUSERS  
IN ALUMINIUM WITH DAMPER  
AND CENTRAL BAFFLE**  
1-2-3-4 SLOTS

 **DIFFUSEUR LINÉAIRE DE  
REFOULEMENT EN ALUMINIUM  
AVEC REGISTRE ET  
DÉFLECTEUR CENTRAL**  
À 1-2-3-4 FENTES

 **LINEARER ZULUFT-DIFFUSOR  
AUS ALUMINIUM MIT  
SCHIEBER UND ZENTRALER  
STÖRKLAPPE - 1-2-3-4**  
SCHLITZE

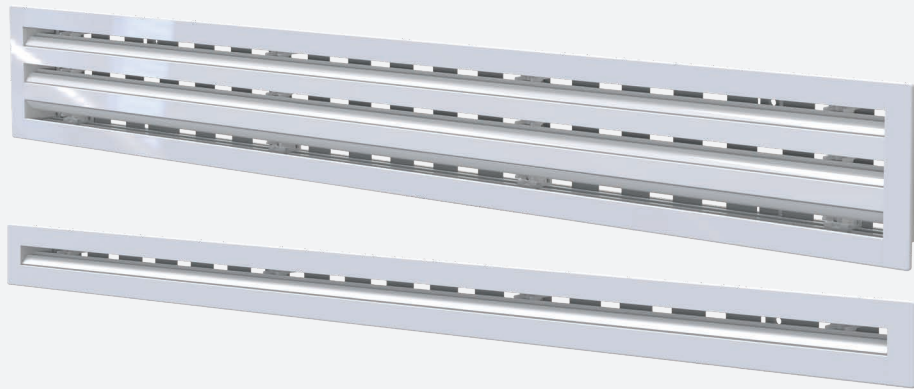

  
MATT  
WHITE

 **LINEAR INTAKE DIFFUSERS  
IN ANTI-CONDENSATE PVC  
PLASTIC**  
1-2-3-4 SLOTS

 **DIFFUSEUR LINÉAIRE DE  
RÉCUPÉRATION EN PLASTIQUE  
PVC ANTI-CONDENSATION**  
À 1-2-3-4 FENTES

 **LINEARER RÜCKLAUF-  
DIFFUSOR AUS PVC MIT  
KONDENSATSCHUTZ - 1-2-3-4**  
SCHLITZE

 **LINEAR INTAKE DIFFUSERS  
IN ALUMINIUM**  
1-2-3-4 SLOTS

 **DIFFUSEUR LINÉAIRE DE  
RÉCUPÉRATION EN  
ALUMINIUM À 1-2-3-4 FENTES**

 **LINEARER RÜCKLAUF-  
DIFFUSOR AUS ALUMINIUM  
MIT - 1-2-3-4 SCHLITZE**

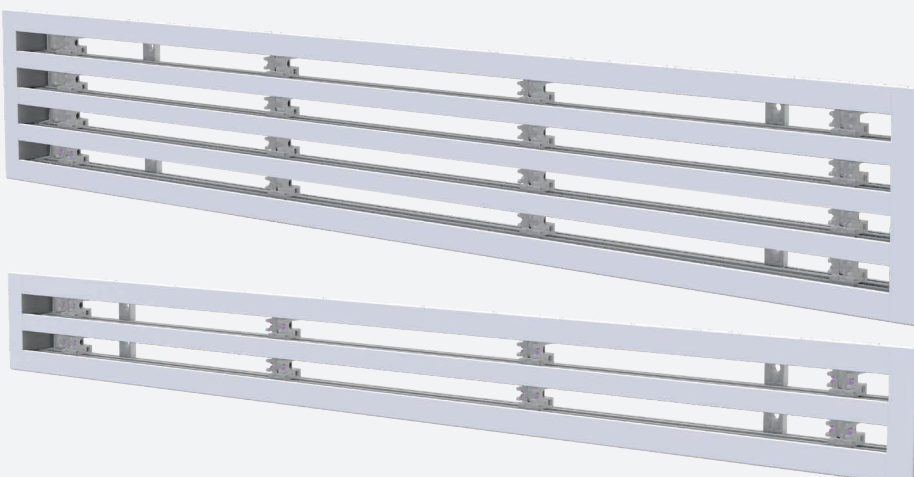



  
MATT  
WHITE

 **LINEAR RETRACTING DELIVERY AND INTAKE DIFFUSERS IN ANTI-CONDENSATE PVC PLASTIC WITH INSULATED PLENUM**

 **DIFFUSEUR LINÉAIRE DE RÉCUPÉRATION ESCAMOTABLE EN PLASTIQUE PVC ANTI-CONDENSATION ET PLÉNUM ISOLÉ**

 **LINEARER ZULUFT-DIFFUSOR - UNTERPUTZ - AUS PVC MIT KONDENSATSCHUTZ MIT SCHIEBER UND ISOLIERTEM PLENUM**

 **LINEAR RETRACTING DELIVERY AND INTAKE DIFFUSERS IN ALUMINIUM WITH INSULATED PLENUM**

 **DIFFUSEUR LINÉAIRE DE RÉCUPÉRATION ESCAMOTABLE EN ALUMINIUM AVEC PLÉNUM ISOLÉ**

 **LINEARER ZULUFT-DIFFUSOR - UNTERPUTZ - AUS ALUMINIUM MIT SCHIEBER UND ISOLIERTEM PLENUM**



 **LOWERED INSULATED PLENUM WITH UPPER COUPLER FOR LINEAR DIFFUSER WITH 1-2-3-4 SLOTS**

 **PLÉNUM ISOLÉ SURBAISSÉ AVEC RACCORD SUPÉRIEUR POUR DIFFUSEUR LINÉAIRE À 1-2-3-4 FENTES**

 **ISOLIERTES ABGESENKTES PLENUM MIT OBEREM ANSCHLUSS FÜR LINEAREN DIFFUSOR 1-2-3-4 SCHLITZE**

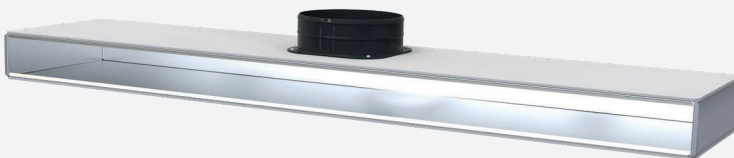

*Image referring to the model with a slot*

**AVAILABLE FROM FEBRUARY 2025**



 **THERMAL FLEXIBLE DUCTED PIPE - DOUBLE-WALLED ARMoured ALUMINIUM PHONIC**

 **TUBE FLEXIBLE CANALISÉ THERMIQUE - PHONIQUE EN ALUMINIUM À DOUBLE PAROI BLINDÉ**

 **KANALISIERTER SCHLAUCH, WÄRME- UND SCHALLDÄMPFEND - AUS ALUMINIUM, DOPPELWANDIG GEPANZERT**





**AVAILABLE FROM FEBRUARY 2025**

CODE	DESCRIPTION	INNER Ø [mm]	M.U.	 Multiple order M.U.
PWC400021	EN 13501-1 THERMAL FLEXIBLE DUCTED PIPE - DOUBLE-WALLED ARMoured ALUMINIUM PHONIC Ø102 mm L.10 m	102	PCS	1
PWC400022	EN 13501-1 THERMAL FLEXIBLE DUCTED PIPE - DOUBLE-WALLED ARMoured ALUMINIUM PHONIC Ø127 mm L.10 m	127	PCS	1
PWC400023	EN 13501-1 THERMAL FLEXIBLE DUCTED PIPE - DOUBLE-WALLED ARMoured ALUMINIUM PHONIC Ø152 mm L.10 m	152	PCS	1
PWC400024	EN 13501-1 THERMAL FLEXIBLE DUCTED PIPE - DOUBLE-WALLED ARMoured ALUMINIUM PHONIC Ø165 mm L.10 m	165	PCS	1
PWC400025	EN 13501-1 THERMAL FLEXIBLE DUCTED PIPE - DOUBLE-WALLED ARMoured ALUMINIUM PHONIC Ø204 mm L.10 m	204	PCS	1
PWC400026	EN 13501-1 THERMAL FLEXIBLE DUCTED PIPE - DOUBLE-WALLED ARMoured ALUMINIUM PHONIC Ø254 mm L.10 m	254	PCS	1

## BBR

 **TWO-STAGE VACUUM PUMP WITH RECHARGEABLE BATTERY AND VACUUM GAUGE IN CARRYING CASE**

 **POMPE À VIDE À DEUX ÉTAGES AVEC BATTERIE RECHARGEABLE ET VACUOMÈTRE DANS UNE MALLETTE**

 **ZWEISTUFIGE VAKUUMPUMPE MIT WIEDERAUFLADBARER BATTERIE UND VAKUUMMETER IM KOFFER**

**R32**

**AVAILABLE FROM APRIL 2025**



CODE	DESCRIPTION	M.U.	 Multiple order M.U.
TSC100043	TWO-STAGE VACUUM PUMP MODEL TS84 BBR FOR R32 GAS	PCS	1
TSC100044	TWO-STAGE VACUUM PUMP MODEL TS122 BBR FOR R32 GAS	PCS	1

## BEV-BO

 **TWO-STAGE VACUUM PUMP FOR R32 GAS**

 **POMPE À VIDE À DEUX ÉTAGES POUR GAZ R32**

 **ZWEISTUFIGE VAKUUMPUMPE MIT MAGNETVENTIL FÜR R32-GAS**

**R32**

**AVAILABLE FROM APRIL 2025**



CODE	DESCRIPTION	M.U.	 Pieces per box
TSC100042		PCS	1

## BEV-MB

 **TWO-STAGE VACUUM PUMP WITH RECHARGEABLE BATTERY AND VACUUM GAUGE IN CARRYING CASE**

 **POMPE À VIDE À DEUX ÉTAGES AVEC ÉLECTROVANNE ET VACUOMÈTRE INTÉGRÉS EN BAIN D'HUILE POUR GAZ R32 AVEC MOTEUR SANS BALAIS**

 **ZWEISTUFIGE VAKUUMPUMPE MIT INTEGRIERTEM MAGNETVENTIL UND ÖLBAD-VAKUUMMETER FÜR GAS R32 MIT BRUSHLESS-MOTOR**

**R32**

AVAILABLE FROM APRIL 2025



CE

CODE	DESCRIPTION	M.U.	 Multiple order M.U.
TSC100035	TWO-STAGE VACUUM PUMP TS56 BEV-MB WITH BRUSHLESS MOTORS FOR R32 GAS	PCS	1
TSC100036	TWO-STAGE VACUUM PUMP TS84 BEV-MB WITH BRUSHLESS MOTORS FOR R32 GAS	PCS	1
TSC100037	TWO-STAGE VACUUM PUMP TS112 BEV-MB WITH BRUSHLESS MOTORS FOR R32 GAS	PCS	1
TSC100038	TWO-STAGE VACUUM PUMP TS168 BEV-MB WITH BRUSHLESS MOTORS FOR R32 GAS	PCS	1

## RHTSB

 **1 HP RECOVERY AND RECYCLING STATION WITH BRUSHLESS MOTORS FOR R32 GAS**

 **STATION DE RÉCUPÉRATION ET DE RECYCLAGE DE 1 HP AVEC MOTEURS SANS BALAIS POUR GAZ R32**

 **RÜCKGEWINNUNGS- UND RECYCLINGSTATION ZU 1 HP MIT BRUSHLESS-MOTOREN FÜR GAS R32**

**R32**

AVAILABLE FROM APRIL 2025



CE

CODE	DESCRIPTION	M.U.	 Multiple order M.U.
TSC100046	1 HP RECOVERY AND RECYCLING STATION WITH BRUSHLESS MOTORS FOR R32 GAS	PCS	1

 4-WAY DRY GAUGE UNIT FOR R290 - 600

 GROUPE MANOMÉTRIQUE À SEC 4 VOIES POUR R290 - 600

 4-WEGE TROCKENMANOMETER-BAUSATZ FÜR R290 - 600



**R290**

**AVAILABLE FROM APRIL 2025**

CODE	DESCRIPTION	M.U.	 Multiple order M.U.
TSC200019	4-WAY PRESSURE GAUGE UNIT R290/600	PCS	1

 STRAIGHTENER FOR COPPER PIPES

 REDRESSEUR POUR TUBES EN CUIVRE

 GERADEBIEGER FÜR KUPFERROHRE

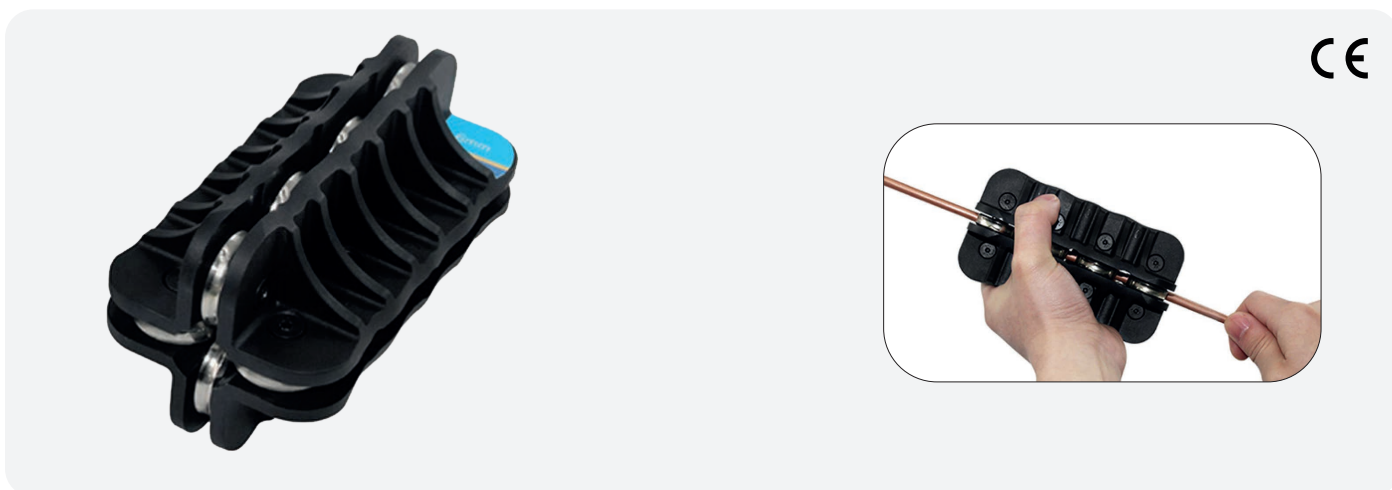

**AVAILABLE FROM APRIL 2025**

CODE	DESCRIPTION	M.U.	 Multiple order M.U.
TSD600001	STRAIGHTENER FOR COPPER PIPE CT-302-02 1/8"	PCS	1
TSD600002	STRAIGHTENER FOR COPPER PIPE CT-302-05 5/16"	PCS	1
TSD600003	STRAIGHTENER FOR COPPER PIPE CT-302-08A 1/2"	PCS	1
TSD600004	STRAIGHTENER FOR COPPER PIPE CT-302-10 5/8"	PCS	1
TSD600005	STRAIGHTENER FOR COPPER PIPE CT-302-12 3/4"	PCS	1

 CORNER BALL VALVE 7/16 F - 1/4 M SAE

 ROBINET À BILLE D'ANGLE 7/16 F - 1/4 M SAE

 ECKVENTIL-KUGELHAHN 7/16 F - 1/4 M SAE



CE

R32

AVAILABLE FROM APRIL 2025

CODE	DESCRIPTION	M.U.	 Multiple order M.U.
TSC300007	CORNER BALL VALVE CYLINDER R 600A 1 litre	PCS	1

 BENDING KIT

 KIT DE COURBURE

 BIEGESATZ

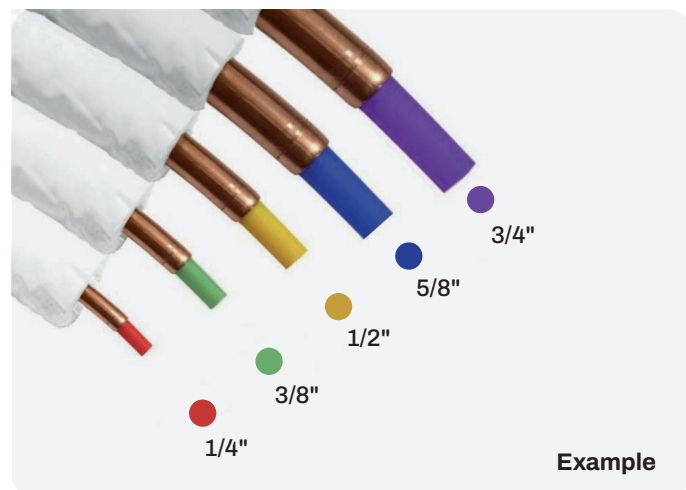
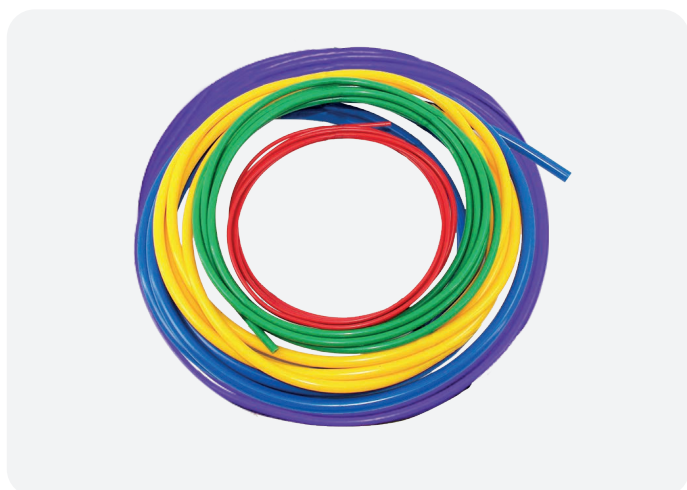

AVAILABLE FROM APRIL 2025

CODE	DESCRIPTION	M.U.	 Multiple order M.U.
TSC600081	BENDING KIT - 5 PCS. (1/4",3/8",1/2",5/8",3/4")	KIT	1
TSC600082	BENDING KIT - 3 PCS. (1/2",5/8",3/4")	KIT	1
TSC600083	BENDING KIT - 3 PCS. (1/4",3/8",1/2")	KIT	1

# STAY UP TO DATE ON UR NEW PRODUCTS

[www.tecnosystemi.com](http://www.tecnosystemi.com)

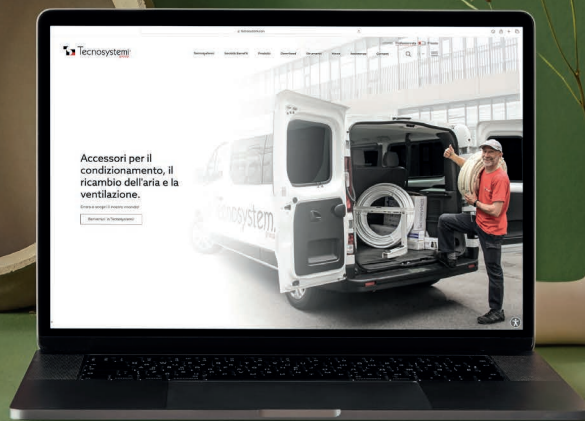

# FOLLOW US ON OUR SOCIAL NETWORK

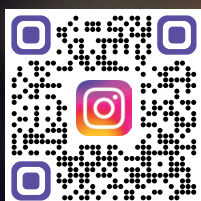



## Tecnosystemi S.p.A. Società Benefit

### PLANT 1

Via dell'Industria, 2/4  
Z.I. San Giacomo di Veglia  
31029 Vittorio Veneto (Treviso)

### PLANT 2

Via Caduti del Lavoro, 7  
Z.I. San Giacomo di Veglia  
31029 Vittorio Veneto (Treviso)

Tel +39 0438.500044

Fax +39 0438.501516

[info@tecnosystemi.com](mailto:info@tecnosystemi.com)

C.F. - P. IVA - R.I.TV IT02535780247

Cap. Soc. € 5.000.000,00 i.v.