

HSTT 145/60-70

STL 160-140R supports for fixing to tiles on roofs

- cod. 11110705 - cod. 11110705BOX

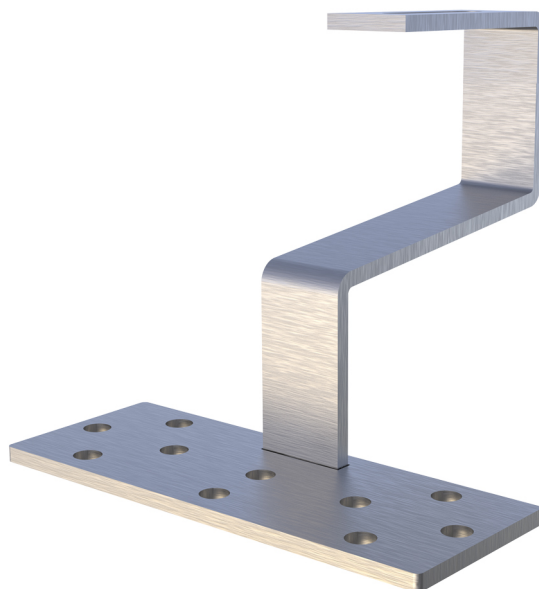

TECHNICAL SPECIFICATIONS:

- Material: AISI 304 stainless steel
- Flexural modulus of elasticity: 196000 N/mm²
- Tensile breaking load: 515 N/mm²
- Hook dimensions: 30mm x 5mm thickness
- 10 holes Ø 9 prepared for plate fixing

TECHNICAL DRAWING:

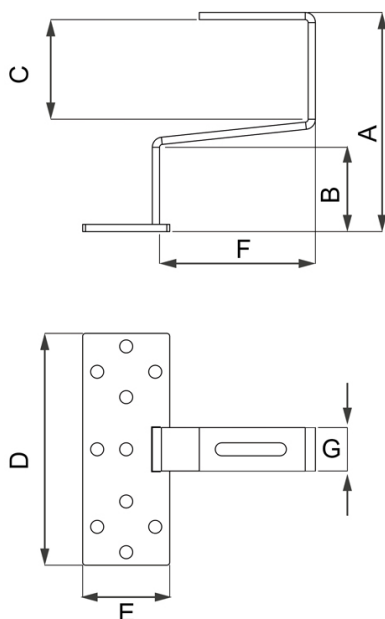

FULL SIZED:

CODE	A [mm]	B [mm]	C [mm]	D [mm]	E [mm]	F [mm]	G [mm]
11110705	145	60	70	160	60	110	30
11110705BOX	145	60	70	160	60	110	30

APPLICATION:

Fixing of photovoltaic systems on roofing tiles supported by strips of varying thickness.

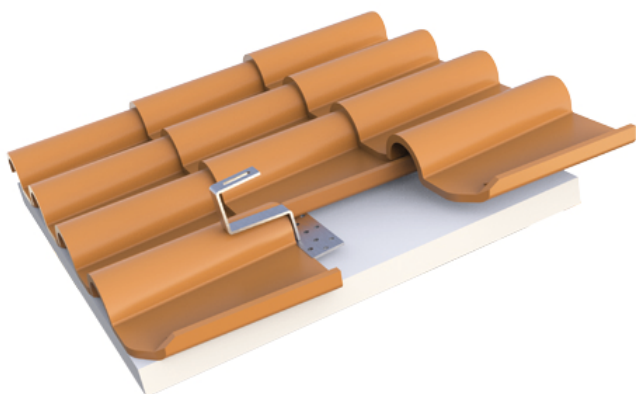

ITEMS

CODE	DESCRIPTION
11110705	SUPPORT FOR FIXING ON ROOFS WITH TILES HSTT 145/60-70 INOX AISI 304
11110705BOX	SUPPORT FOR FIXING ON ROOFS WITH TILES HSTT 145/60-70 INOX AISI 304 - BOX 10 pcs

All rights relating to this publication are the exclusive property of Tecnosystemi SpA.

Tecnosystemi SpA reserves the right to make changes at any time and without notice, for technical or commercial needs.