

VR180

very high efficiency ductable static heat recovery unit with automatic by-pass included for horizontal / vertical / right / left installation

- cod. ACC200014

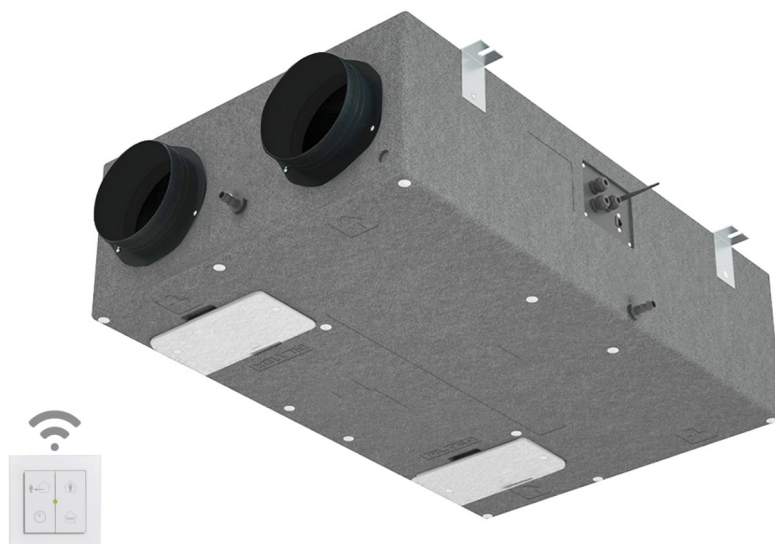

TECHNICAL SPECIFICATIONS:

- Power supply 230V - 50Hz
- Wireless plug and play adjustment included
- Countercurrent heat recovery unit entirely made of plastic material
- Free-standing structure in PPE
- Removable delivery and intake filters
- Equipped with coupling for condensate drain
- Plug fan fans with Brushless EC motor
- Removable grade G4 filters
- Optional efficiency filter F7

WIRELESS REGULATOR INCLUDED:

- Speed control
- By-pass
- Antifreeze
- Filter clogging
- Precise alarms
- Booster function

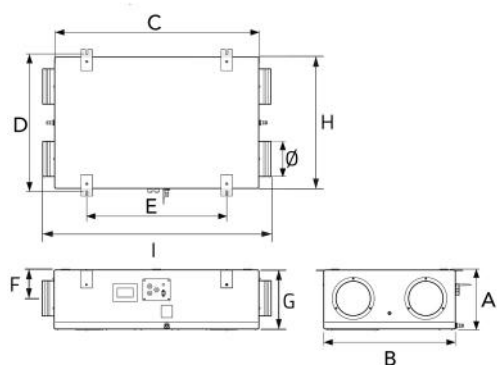

DIMENSIONS

ACC200014	A [mm]	B [mm]	C [mm]	D [mm]	E [mm]	F [mm]	G [mm]	H [mm]	I [mm]	Ø [mm]
CODE	268	580	900	609	617	125	260	320	1005	156

VERTICAL WALL INSTALLATION:

Leggenda

- EX = espulsione
- R = ripresa
- FA = aria esterna
- S = mandata

Legend

- EX = exhaust air
- R = return
- FA = fresh air
- S = supply

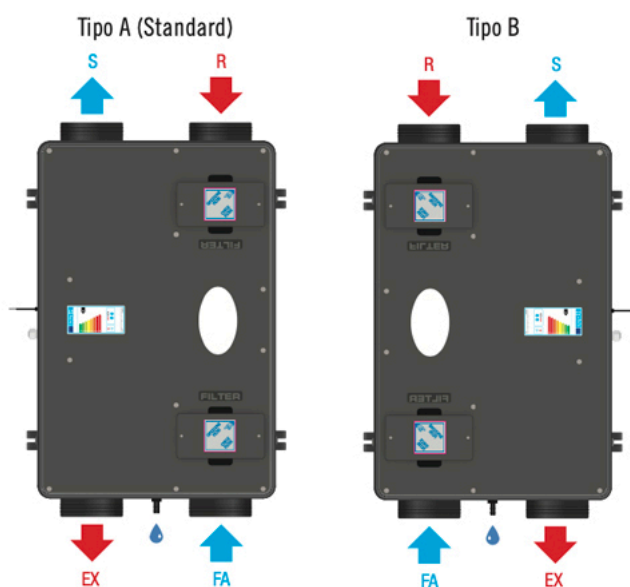

HORIZONTAL INSTALLATION ON THE CEILING:

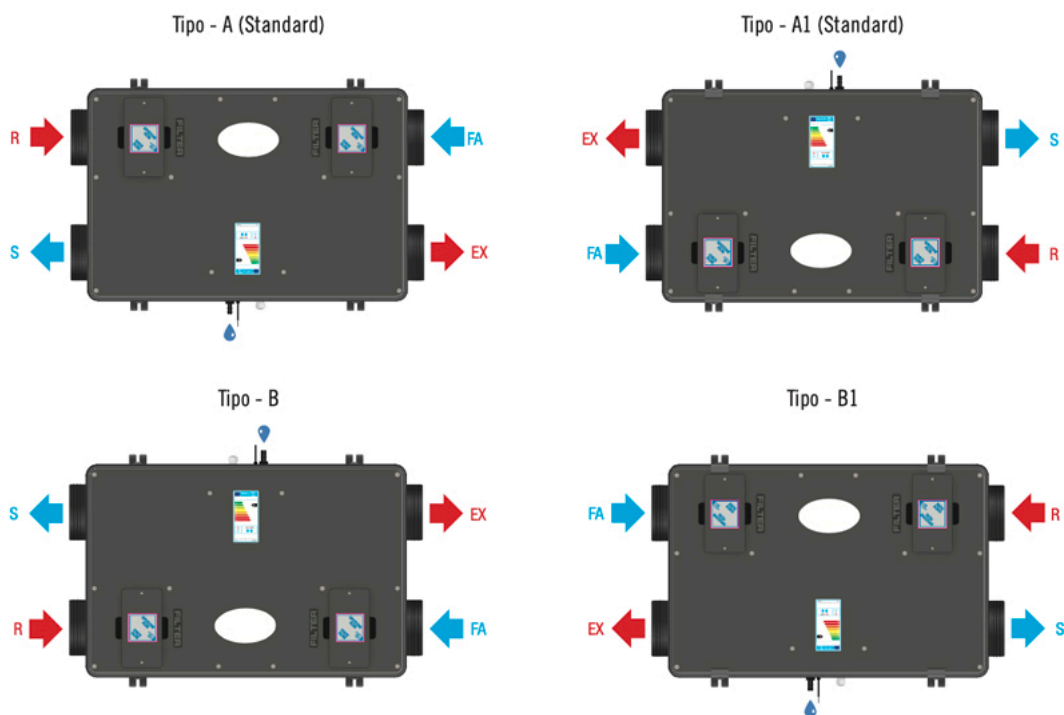

TECHNICAL DATA

MAXIMUM FLOW RATE (at 100 Pa) [m³/h]	UNIQUE STATIC PRESSURE [Pa]	DUCTS DIAMETER [mm]
180	100	Ø150

DATA FOR INDIVIDUAL FAN

RATED POWER [W]	RPM [1/min]	THE RATED [A]	VOLTAGE [V]	FREQUENCY [Hz]
27	3700	0.27	230	50

FILTERS

FILTER: DELIVERY/INTAKE	FILTER: DELIVERY/INTAKE ON REQUEST
G4	F7

AIR DUCT PERFORMANCE EN 13141-7:2011 - USEFUL STATIC PRESSURE

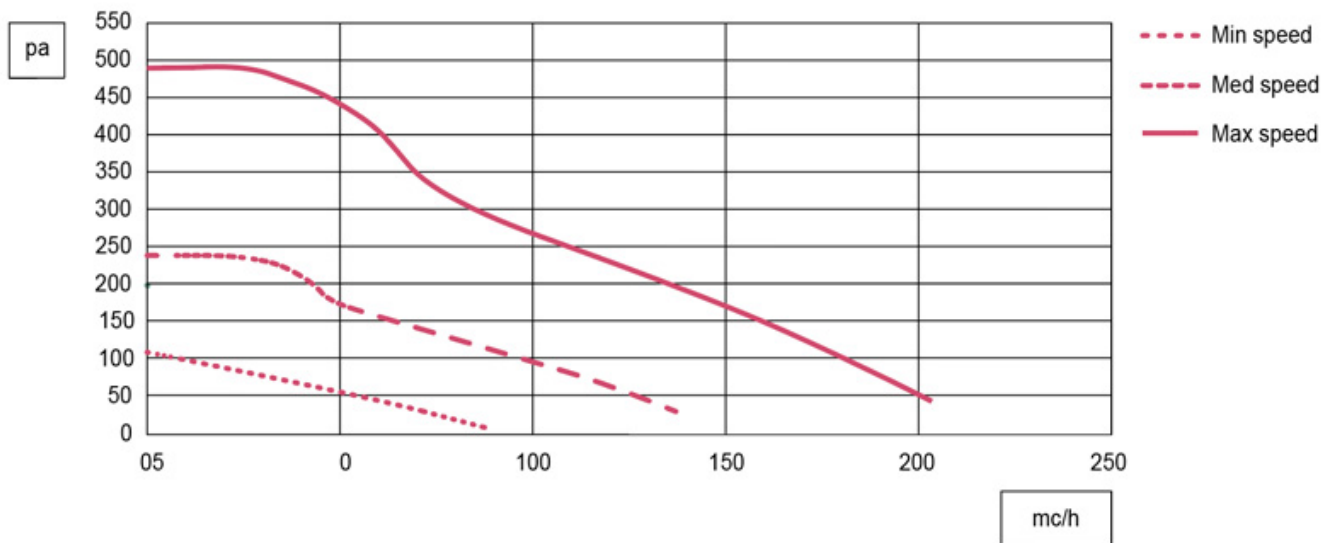

Data with G4 filter
 Efficiency filter load losses F7 80 Pa at maximum flow with clean filter

GRAPH SPECIFIC FAN POWER

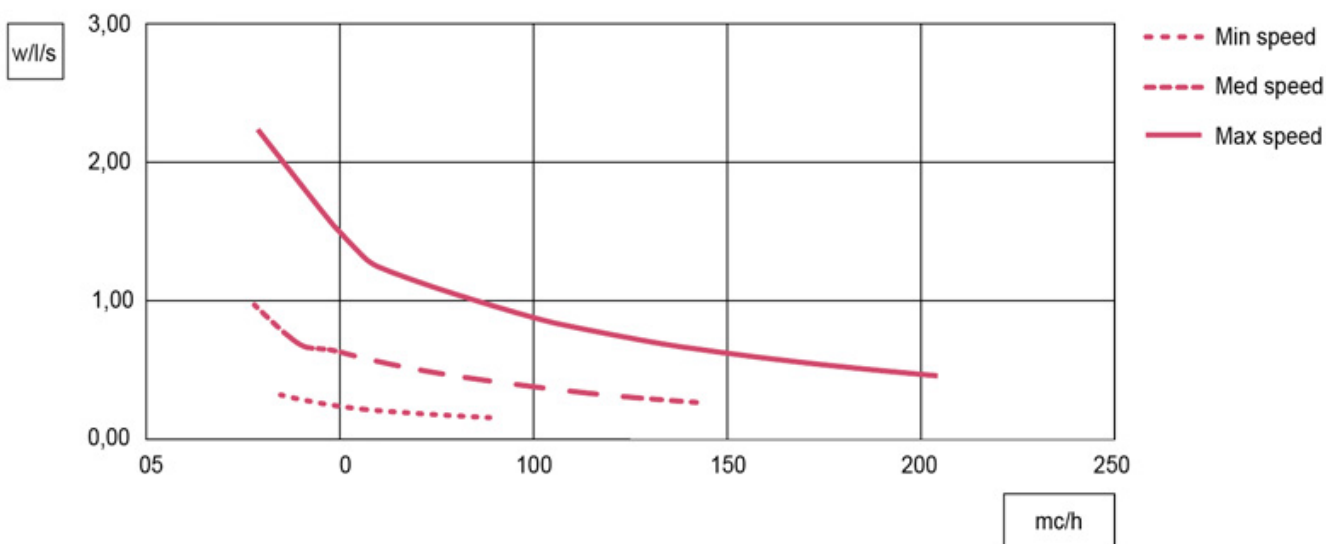

Data for individual fan

HEAT EXCHANGER HEAT EFFICIENCY GRAPH ACCORDING TO EN 308 - SUMMER

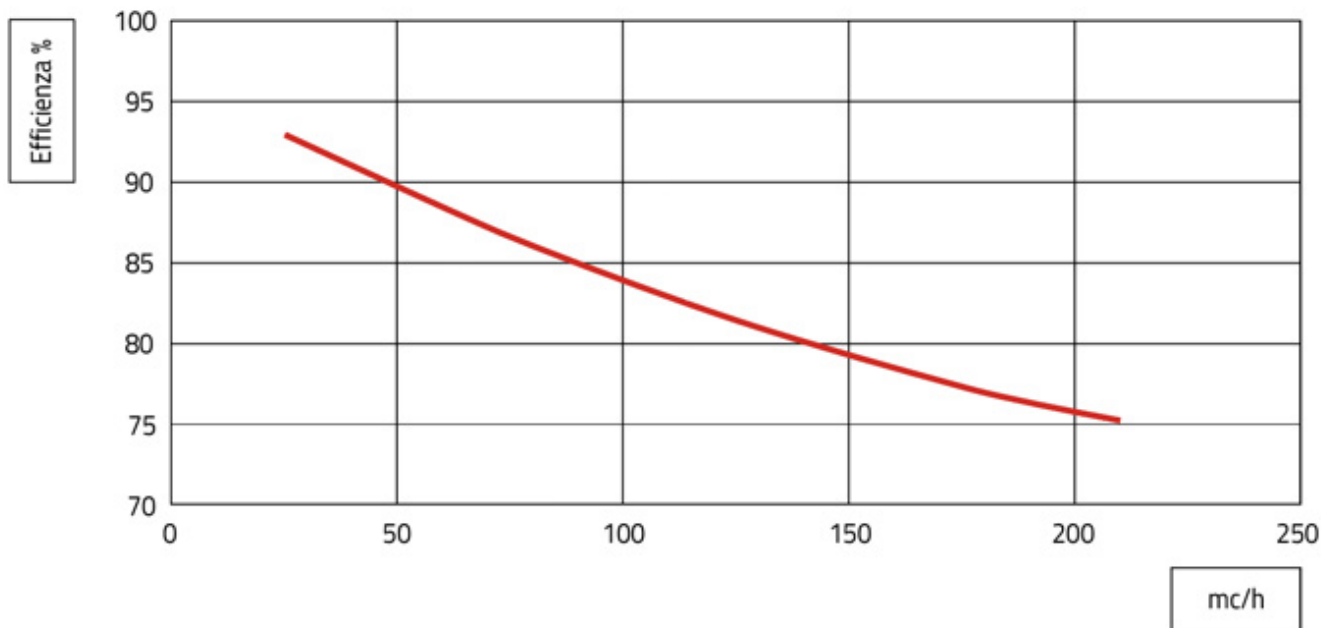

Summer efficiency diagram:
 Outside air: 32 °C / 50 % U.R.
 Ambient air: 26 °C / 50 % U.R.

HEAT EXCHANGER HEAT EFFICIENCY GRAPH ACCORDING TO EN 308 - WINTER

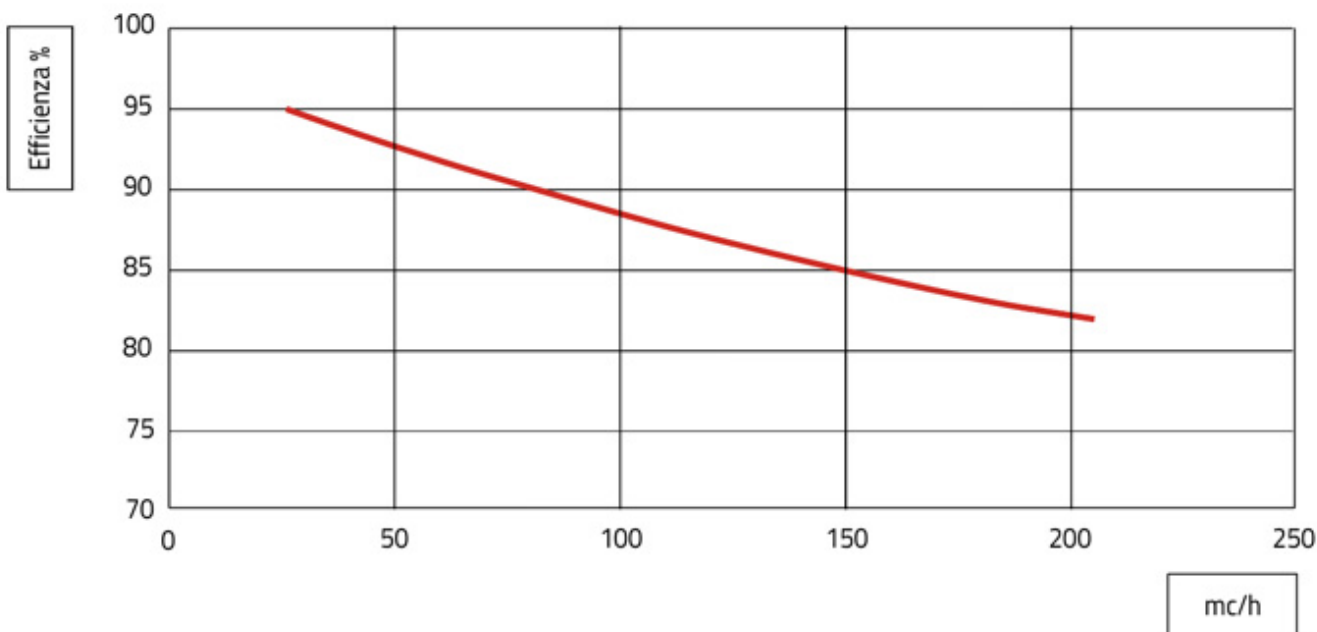

Winter efficiency diagram:
 Outside air: -5 °C / 80 % U.R.
 Ambient air: 20 °C / 50 % U.R.

Ecodesign:

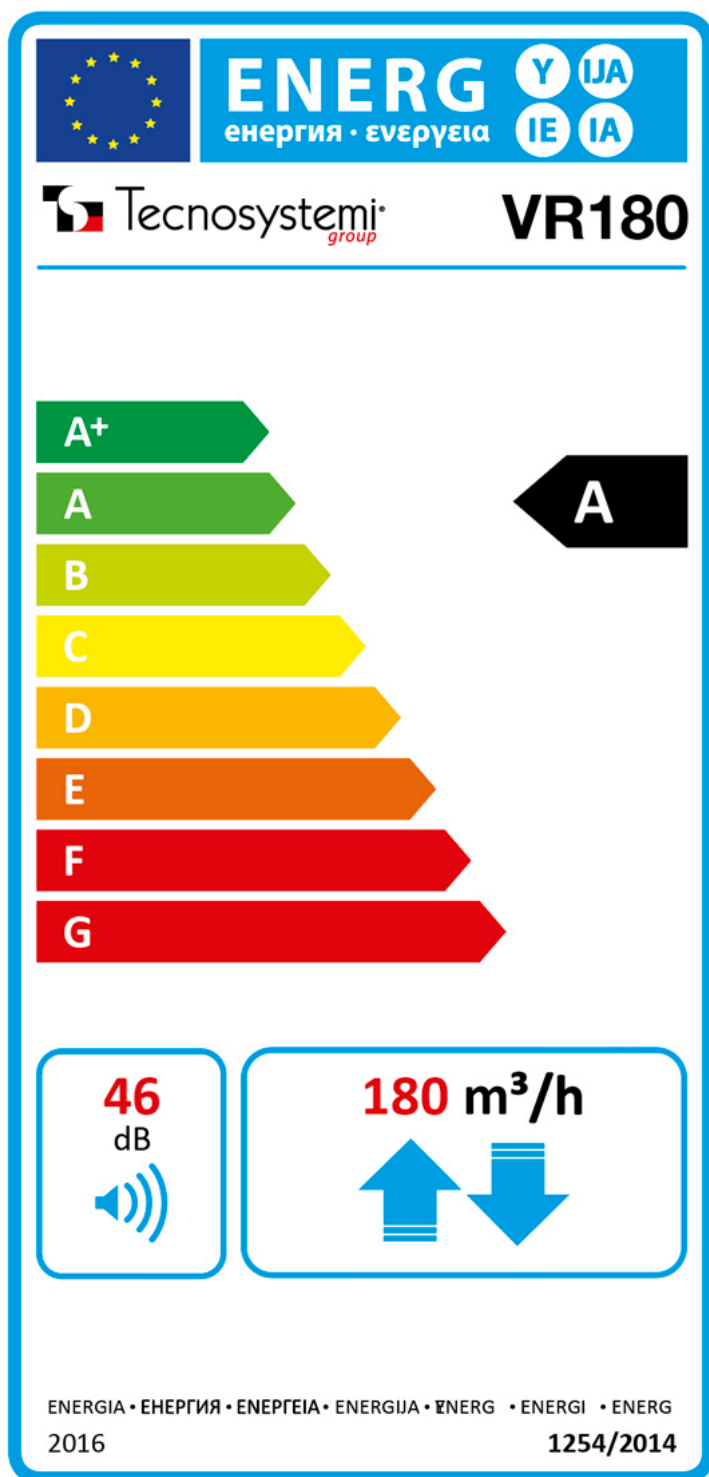

DICHIARAZIONE DI PRESTAZIONE ECODESIGN - REGOLAMENTO (UE) 1253/2014

SPECIFICATIONS:	DATA		
Manufacturer's name or trade name	Tecnosystemi		
Identificativo del modello del fornitore e opzioni installate	ACC200014 / VR180		
Climate	Temperate	Cold	Heat
SEC [kWh/(m ² a)] for all types of climate (temperate, warm, cold)	-35,83	-76,93	-12,92
SEC Class	A	A+	E
Declared type of ventilation unit	Bidirectional UVR		
Type of drive installed	Multiple speed drive		
Type of heat recovery system	recovery		
Thermal efficiency ¹	81,1%		
Maximum flow rate [m ³ /h] ²	180		
Total electric power maximum range [W]	60		
Power Sound power level (LWA) in [dB(A)] ³	46		
Reference flow rate [m ³ /s]	126		
Reference pressure difference [Pa]	50		
SPI in [W/m ³ /h] ⁵	0,21		
Control factor and type	1 manual control		
Maximum percentage of external drawing [%] ⁶	1,2		
Maximum percentage of external drawing [%] ⁶	2,5		
internet address	www.tecnosystemi.com		

NOTES:

NOTES	DATA
1.	Efficiency according to EN13141-7:2010 at 50 Pa reference flow Efficiency according to EN13141-7:2010 at 50 Pa reference flow
2.	Maximum flow at 100 Pa external pressure
3.	Radiation from the housing to the reference flow at 50 Pa external pressure
4.	The percentage of the reference flow rate is 70% of the maximum flow rate at 50 Pa of external pressure in accordance with EN13141-7:2010
5.	IN ACCORDANCE WITH EN13141-7:2010 at the reference range
6.	IN ACCORDANCE WITH EN13141-7:2010
SEC.	Specific energy consumption

ITEMS

ACC200014	
CODE	DESCRIPTION

All rights relating to this publication are the exclusive property of Tecnosystemi SpA.

Tecnosystemi SpA reserves the right to make changes at any time and without notice, for technical or commercial needs.