

Linear diffuser in ALUMINIUM with damper and central baffle - 4 slots

- cod. PWD301678 - cod. PWD301681 - cod. PWD301684
- cod. PWD301687 - cod. PWD301690

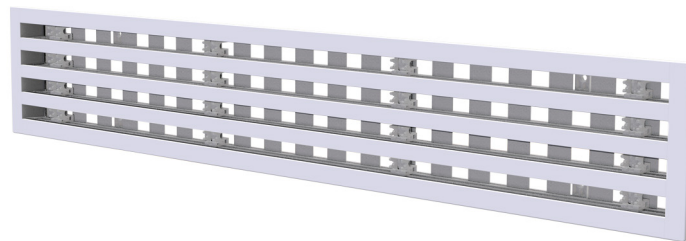

DESCRIPTION

Visible linear diffuser in aluminium with adjustable calibration damper, central baffle with 4 slots, white. Diffusers are used in places where the ceiling design has to be assured, such as offices, meeting rooms and hotels, ensuring uniform air diffusion and high thermal induction. It is fixed to the plenum, which can be purchased separately, using front screws and mobile C brackets. The damper is used to control the required amount of air and can be calibrated using a screwdriver. Housings are obtained from inside the profiles to enable the mounting of adjustable PVC baffles. By changing the baffle direction it is possible to deliver the air flow according to the place of installation, if necessary obtaining a Coanda effect.

APPLICATIONS

Diffuser ideal for wall or ceiling installations, in delivery and intake, at a height between 2.5 m and 3.1 m.

ACCESSORIES

- Plenum in insulated galvanised metal sheet, can be purchased separately.
- Continuity kit, can be purchased separately.

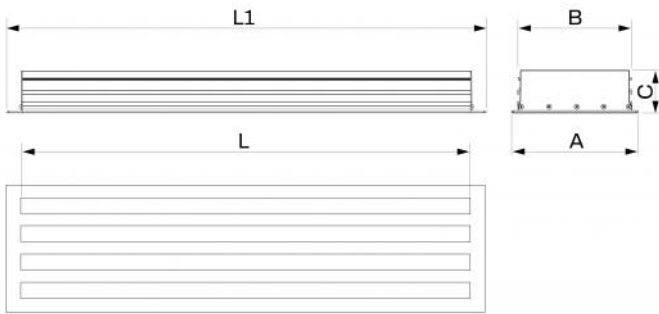

DIMENSIONS

CODE	L [mm]	L1 [mm]	A [mm]	B [mm]	C [mm]
PWD301678	600	645	183	166	60
PWD301681	800	845	183	166	60
PWD301684	1000	1045	183	166	60
PWD301687	1500	1545	183	166	60
PWD301690	2000	2045	183	166	60

INFORMATION

Measures are indicated in millimetres (mm), unless otherwise specified.

LOAD CAPACITY AND PRESSURE DROP CURVES

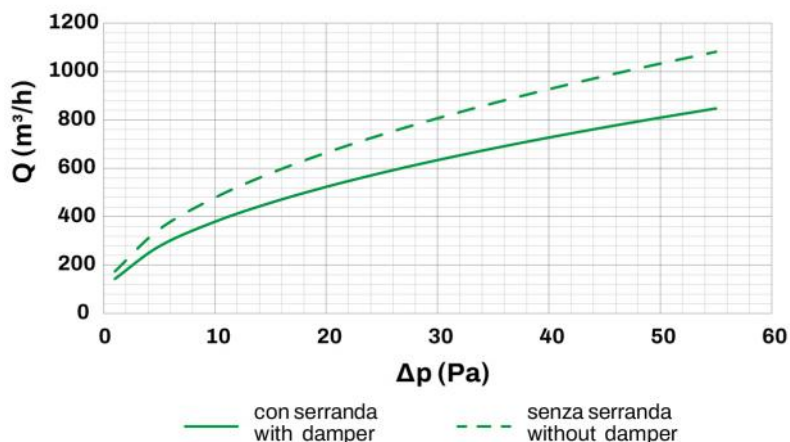

Ak [m²]	Qv min [m³/h]	Qv max [m³/h]	Lwa min [dB(A)]	Lwa max [dB(A)]	DP min [Pa]	DP max [Pa]
0.084	380	810	35	49	10	50

INFORMATION

The data in the table refers to 1000 mm long linear retracting diffusers, with fully open damper and vertical baffle.

SHORTCUT DIAGRAM

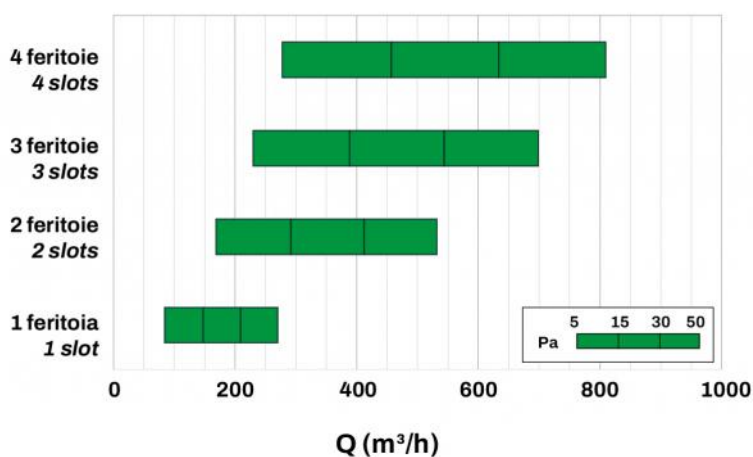

EXAMPLE OF FLOW

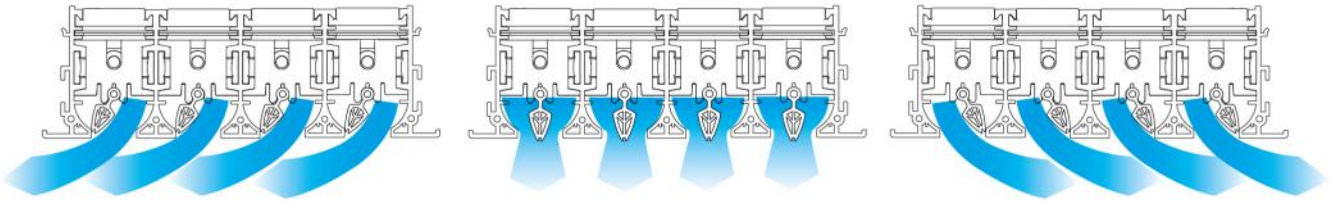

HORIZONTAL FLOW CHART WITH TILTED BAFFLE

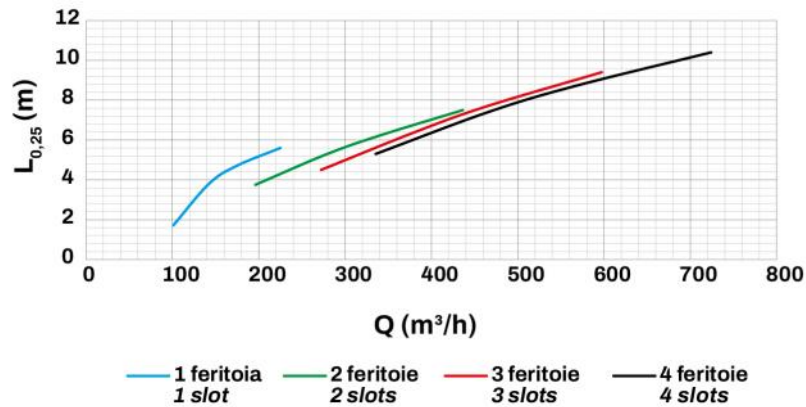

BUILT-IN INSTALLATION BOX FOR WALLS



EXAMPLE OF INSTALLATION:

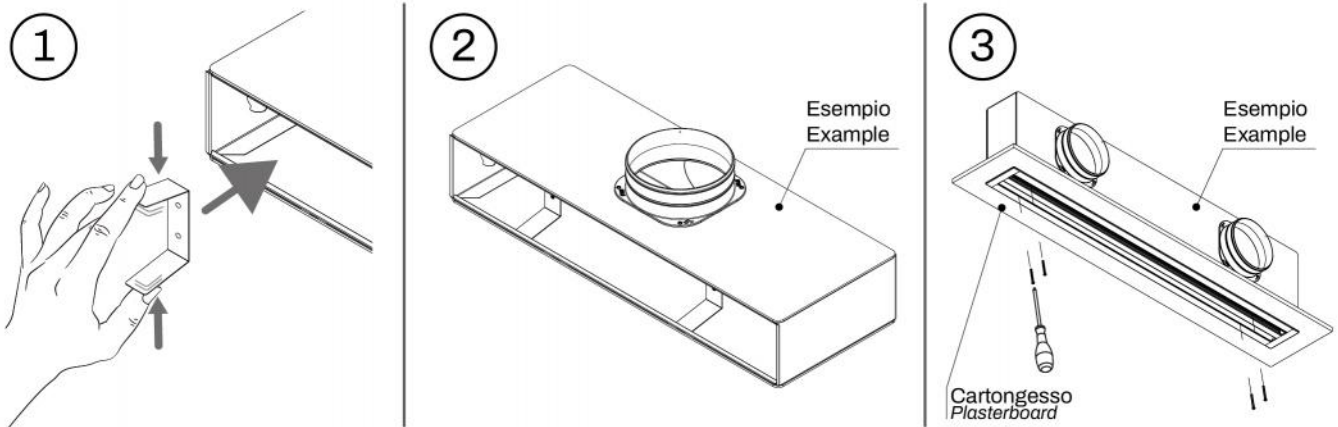

BAFFLE ASSEMBLY

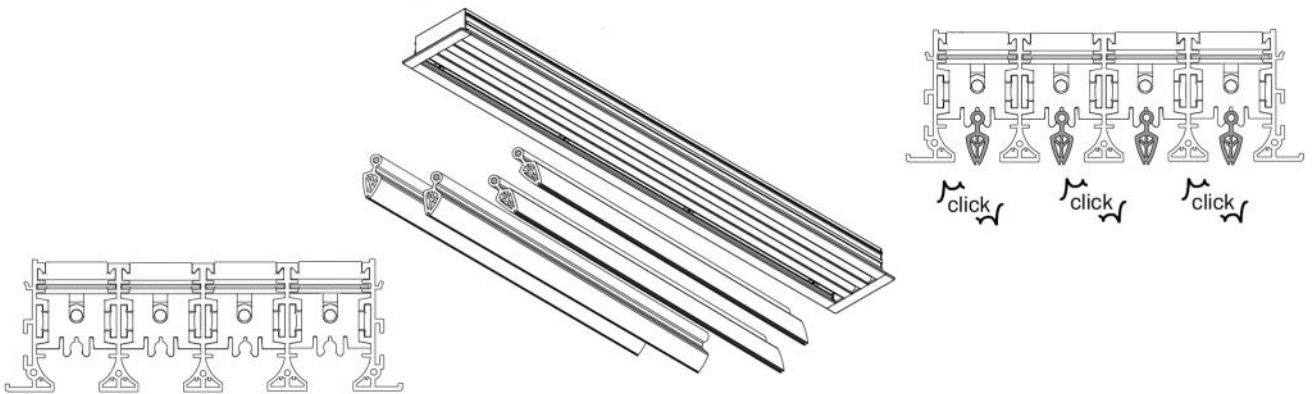

DAMPER ADJUSTMENT

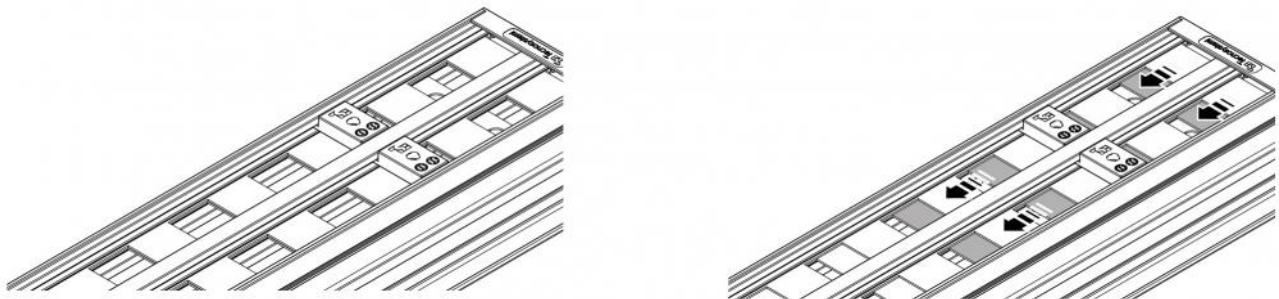

Use a screwdriver to adjust the damper, acting beneath the diffuser.

EXAMPLE OF CONTINUITY KIT FIXING

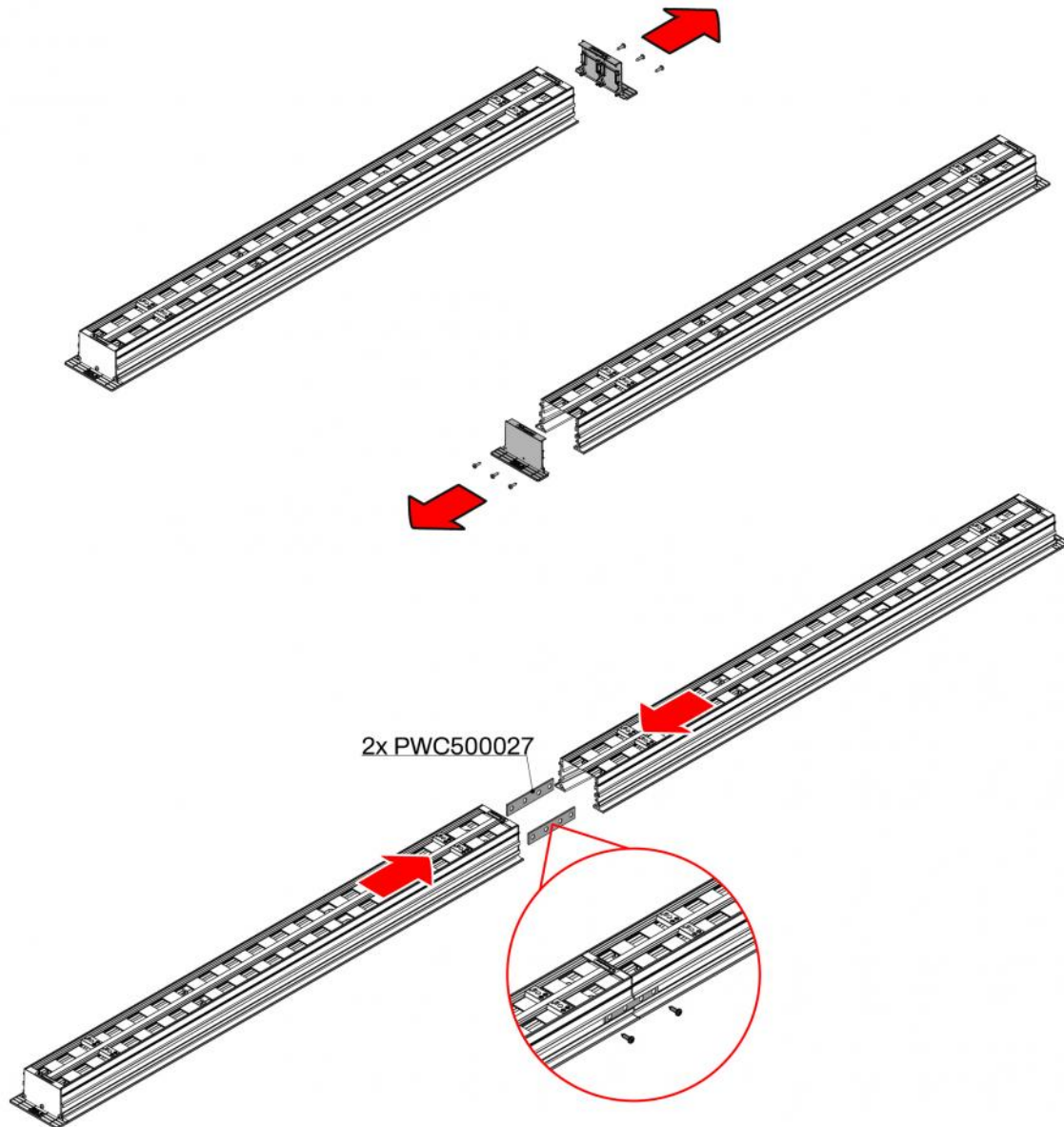

ITEMS

CODE	DESCRIPTION
PWD301678	LINEAR DIFFUSER IN ALUMINIUM 4 SLOTS WITH DAMPER AND CENTRAL DEFLECTOR L600mm WHITE
PWD301681	LINEAR DIFFUSER IN ALUMINIUM 4 SLOTS WITH DAMPER AND CENTRAL DEFLECTOR L800mm WHITE
PWD301684	LINEAR DIFFUSER IN ALUMINIUM 4 SLOTS WITH DAMPER AND CENTRAL DEFLECTOR L1000mm WHITE
PWD301687	LINEAR DIFFUSER IN ALUMINIUM 4 SLOTS WITH DAMPER AND CENTRAL DEFLECTOR L1500mm WHITE
PWD301690	LINEAR DIFFUSER IN ALUMINIUM 4 SLOTS WITH DAMPER AND CENTRAL DEFLECTOR L2000mm WHITE

All rights relating to this publication are the exclusive property of Tecnosystemi SpA.
 Tecnosystemi SpA reserves the right to make changes at any time and without notice, for technical or commercial needs.