

ARIA 2 ELEGANCE T

Built-in tangential air curtain at room temperature

- cod. 12450014 - cod. 12450024 - cod. 12450034



TECHNICAL SPECIFICATIONS:

- 3 models in white
- 3 speeds operated by remote control
- Air curtains are designed for indoor use
- Total integration to the false ceiling
- The unit must be installed horizontally
- Maximum installation height 2.2 m

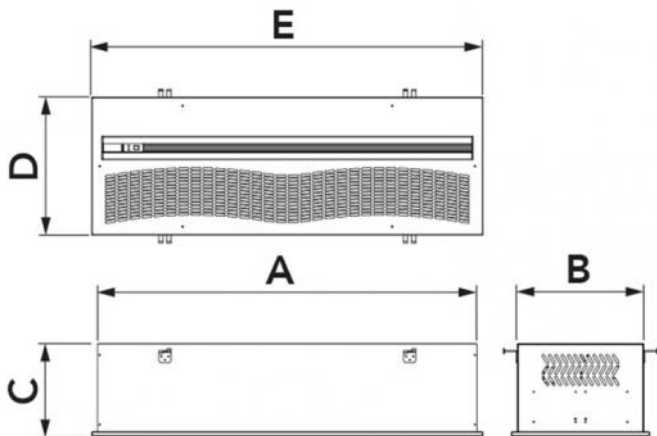

DIMENSIONS

CODE	A [mm]	B [mm]	C [mm]	D [mm]	E [mm]	SUITABLE FOR LARGE DOORS [mm]
12450014	1086	362	270	396	1120	L.1000 H.Max.2200 H.Min.1800
12450024	1440	362	270	396	1472	L.2000 H.Max.2200 H.Min.1800
12450034	2040	362	270	396	2072	L.1500 H.Max.2200 H.Min.1800

TECHNICAL DATA

CODE	MODEL	SUPPLY VOLTAGE [V]	FREQUENCY [Hz]	POWER CONSUMPTION [W]	AIR SPEED AT INLET [m/s]	AIR FLOW RATE [m³/s]	SOUND POWER LEVEL [DB(A)]	WEIGHT [kg]
12450014	1100	230 ac	50	75	I:8 II:9 III:10	I:706 II:768 III:967	I:46 II:51 III:53	22
12450024	1500	230 ac	50	190	I:8 II:9 III:10	I:1135 II:1238 III:1289	I:50 II:53 III:54	33
12450034	2000	230 ac	50	190	I:8 II:9 III:10	I:1419 II:1560 III:1635	I:48 II:51 III:52	47

REMOTE CONTROL

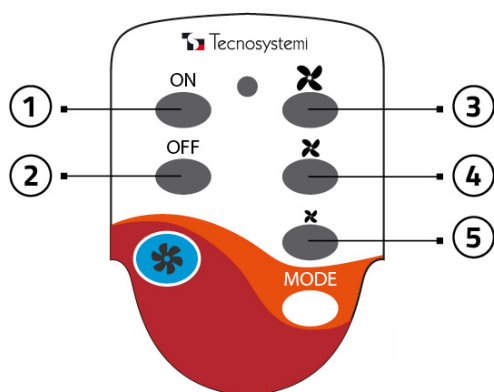

- [1] ON / Turns the appliance on
- [2] OFF / Shuts the appliance off
- [3] Maximum speed
- [4] Medium speed
- [5] Low speed

DASHBOARD LABEL

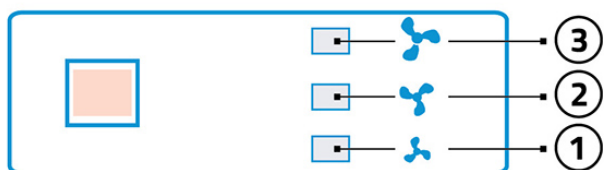

- [1] 1st speed (Min) 1 LED LIT
- [2] 2nd speed (Med) 2 LEDS LIT
- [3] 3rd speed (Max) 3 LEDS LIT

AUTOMATIC START KIT FOR AIR CURTAINS.



This kit, sold separately from the air curtain, allows you to switch the machine on and off by opening and closing the door.

SINGLE-PHASE POWER SUPPLY AND WIRING DIAGRAM

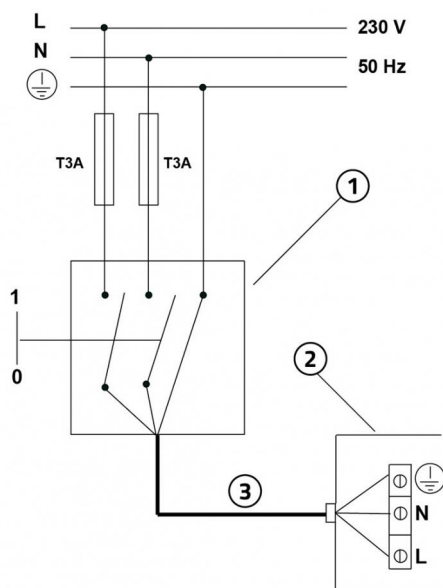

- [1] Omnipolar thermal magnetic protection switch compliant with EN 61508:1
- [2] Power cable 3x2.5 mm²
- [3] Electrical connection box

IMPORTANT!

During the electrical connection, the installer must comply with the polarities indicated by the plate in front of the power supply terminal board.

INSTALLING AND COMMISSIONING THE AUTOMATIC START KIT (optional)

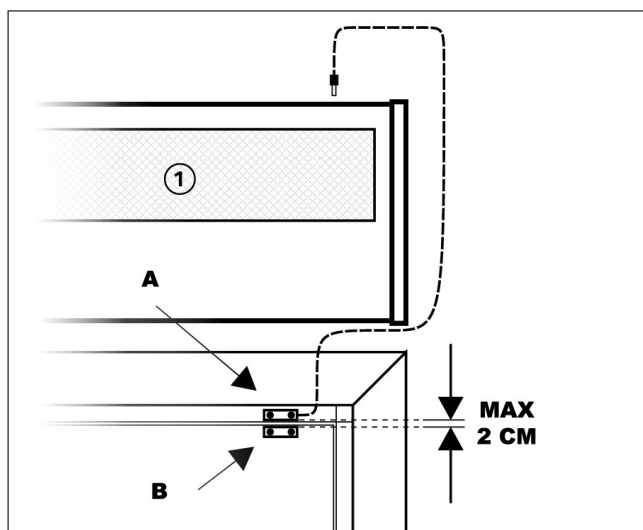

- [1] Air curtain

Connect the wired sensor to the air curtain via jack.

Attach the magnetic sensor A to the door casing or to a solid point with the door frame.

Attach the second sensor to the moving part of the door leaving no more than 2 cm between the two sensors.

When the “automatic start kit” is installed, the air curtain can be switched on and off with the opening / closing of the door.

INSTALLATION AND START-UP

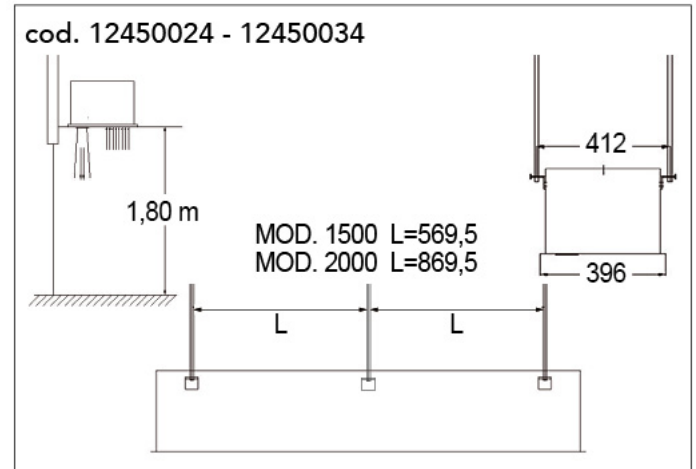
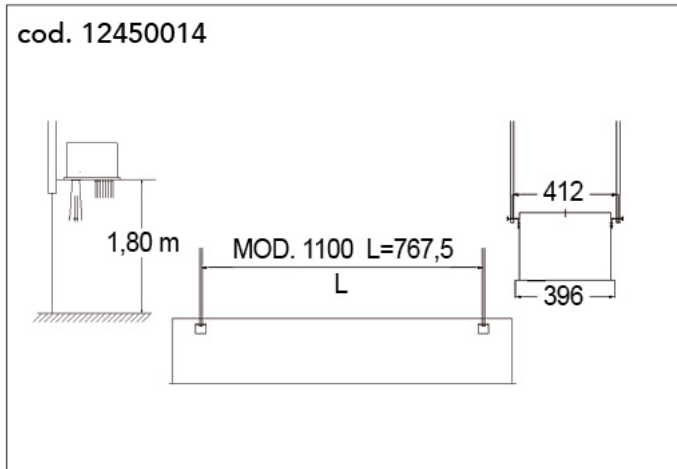

ITEMS

CODE	DESCRIPTION
12450014	"ARIA 2 ELEGANCE T" 1100 BUILT-IN TANGENTIAL AIR CURTAINS AT ROOM TEMPERATURE
12450024	"ARIA 2 ELEGANCE T" 1500 BUILT-IN TANGENTIAL AIR CURTAINS AT ROOM TEMPERATURE
12450034	"ARIA 2 ELEGANCE T" 2000 BUILT-IN TANGENTIAL AIR CURTAINS AT ROOM TEMPERATURE

All rights relating to this publication are the exclusive property of Tecnosystemi SpA.
 Tecnosystemi SpA reserves the right to make changes at any time and without notice, for technical or commercial needs.