

ARIA 3 SILENCE FRONT

Tangential air curtain with front extraction

- cod. 12400011 - cod. 12400013 - cod. 12400021
- cod. 12400031



TECHNICAL SPECIFICATIONS:

- 4 models in white
- 3 speeds operated by remote control
- Air curtains are designed for indoor use
- Panel with 3 LEDs
- Automatic start-up kit on request
- Front air intake
- The unit must be installed horizontally

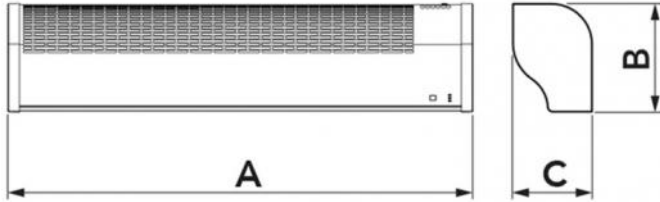

DIMENSIONS

CODE	A [mm]	B [mm]	C [mm]	SUITABLE FOR LARGE DOORS [mm]
12400011	1070	245	180	L.1000 H.3000
12400013	1070	245	180	L.1000 H.3000
12400021	1422	245	180	L.1500 H.3000
12400031	2032	245	180	L.2000 H.3000

TECHNICAL DATA

CODE	MODEL	SUPPLY VOLTAGE [V]	FREQUENCY [Hz]	POWER CONSUMPTION [W]	AIR SPEED AT INLET [m/s]	AIR FLOW RATE [m³/h]	SOUND POWER LEVEL [DB(A)]	WEIGHT [kg]	REMOTE CONTROL
12400011	1100 right single fan	230 ac	50	75	I:9 II:10 III:11	963 1080 1152	50 53 55	11,2	3-speed adjustment
12400013	1100 left single fan	230 ac	50	75	I:9 II:10 III:11	963 1080 1152	50 53 55	11,2	3-speed adjustment
12400021	1500 central double fan	230 ac	50	190	I:9 II:10 III:11	1416 1520 1550	54 55 56	14,7	3-speed adjustment
12400031	2000 central double fan	230 ac	50	190	I:9 II:10 III:11	1494 1692 1818	64 66 68	20,1	3-speed adjustment

REMOTE CONTROL

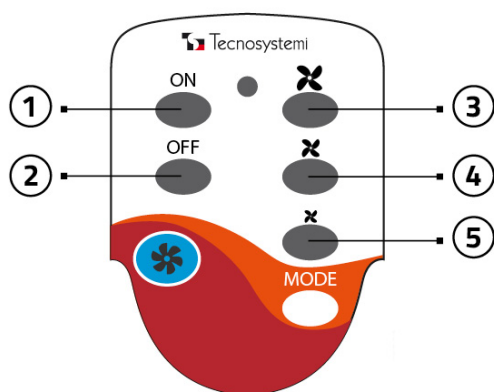

- [1] ON / Turns the appliance on
- [2] OFF / Shuts the appliance off
- [3] Maximum speed
- [4] Medium speed
- [5] Low speed

DASHBOARD LABEL

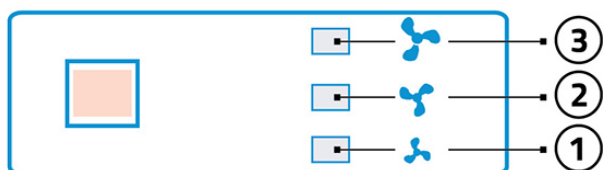

- [1] 1st speed (Min) 1 LED LIT
- [2] 2nd speed (Med) 2 LEDS LIT
- [3] 3rd speed (Max) 3 LEDS LIT

AUTOMATIC START KIT FOR AIR CURTAINS.

This kit, sold separately from the air curtain, allows you to switch the machine on and off by opening and closing the door.



INSTALLING AND COMMISSIONING THE AUTOMATIC START KIT (optional)

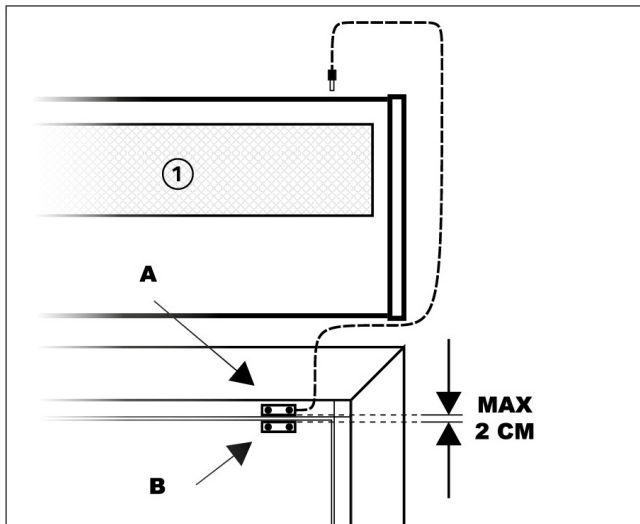

[1] Air curtain

Connect the wired sensor to the air curtain via jack.
 Attach the magnetic sensor A to the door casing or to a solid point with the door frame.
 Attach the second sensor to the moving part of the door leaving no more than 2 cm between the two sensors.
 When the “automatic start kit” is installed, the air curtain can be switched on and off with the opening / closing of the door.

SINGLE-PHASE POWER SUPPLY AND WIRING DIAGRAM

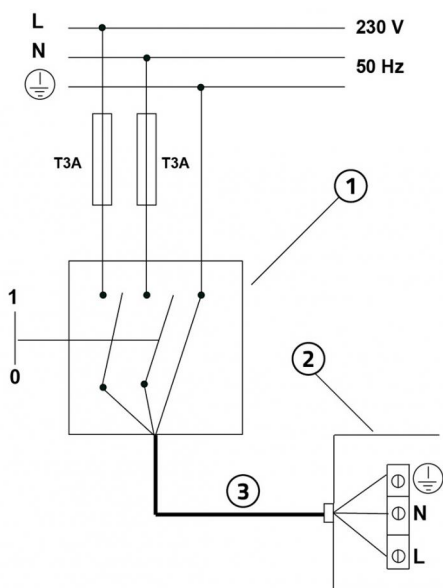

- [1] Omnipolar thermal magnetic protection switch compliant with EN 61508:1
- [2] Power cable 3x2.5 mm²
- [3] Electrical connection box

IMPORTANT!

During the electrical connection, the installer must comply with the polarities indicated by the plate in front of the power supply terminal board.

WALL-MOUNTED DRILLING SPACING MODEL 1000

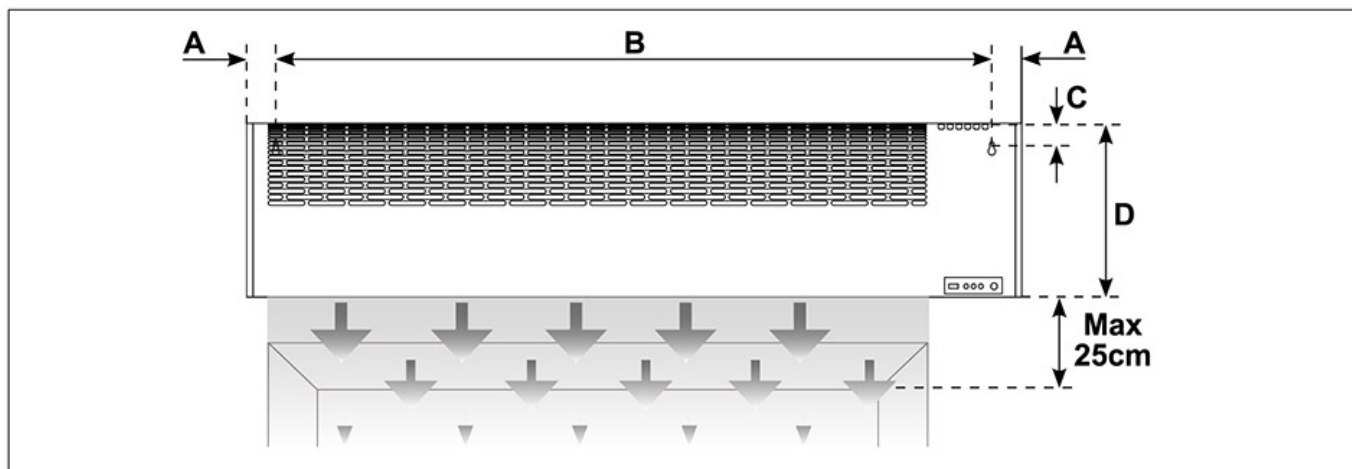

DIMENSIONAL TABLE

CODE	A [mm]	B [mm]	C [mm]	D [mm]
12400011	55	975	28	250
12400013	55	975	28	250

WALL-MOUNTED DRILLING SPACING MODEL 1500/2000 CENTRAL

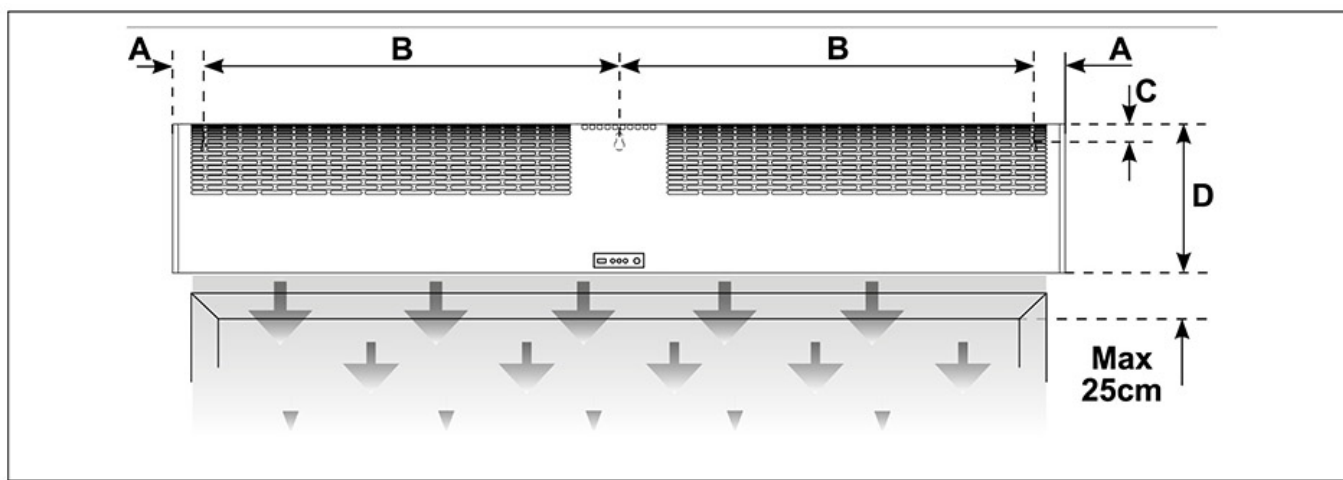

DIMENSIONAL TABLE

CODE	A [mm]	B [mm]	C [mm]	D [mm]
12400011	55	652	28	250
12400013	55	950	28	250

ITEMS

CODE	DESCRIPTION
12400011	"ARIA3 SILENCE FRONT" SINGLE-FAN AIR CURTAINS 1100 DX
12400013	"ARIA3 SILENCE FRONT" SINGLE-FAN AIR CURTAINS 1100 SX
12400021	"ARIA3 SILENCE FRONT" DUAL-FAN AIR CURTAINS 1500 GEN.
12400031	"ARIA3 SILENCE FRONT" DUAL-FAN AIR CURTAINS 2000 GEN.

All rights relating to this publication are the exclusive property of Tecnosystemi SpA. Tecnosystemi SpA reserves the right to make changes at any time and without notice, for technical or commercial needs.