

AIRJET

Centrifugal air curtain with upper extraction with built-in LED bar light

- cod. AAD400001 - cod. AAD400002 - cod. AAD400003
- cod. AAD400004



TECHNICAL SPECIFICATIONS:

- 4 models in white
- 3 speeds selectable by remote control or interface
- Air curtains are designed for indoor use
- Automatic starter kit on request
- Lower bar with LED light strip
- Backlit LCD display
- Upper air intake
- The unit must be installed horizontally

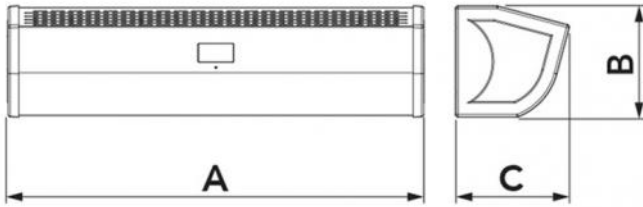

DIMENSIONS

CODE	MODEL	A [mm]	B [mm]	C [mm]	SUITABLE FOR DOORS [mm]
AAD400001	900	900	240	250	L900 H3500
AAD400002	1200	1200	240	250	L1200 H3500
AAD400003	1500	1500	240	250	L1500 H3500
AAD400004	2000	2000	240	250	L1200 H3500

TECHNICAL DATA

CODE	SUPPLY VOLTAGE [V]	FREQUENCY [Hz]	POWER CONSUMPTION [W]	AIR SPEED AT INLET [m/s]	AIR FLOW RATE [m³/h]	SOUND POWER LEVEL [DB(A)]	WEIGHT [kg]
AAD400001	230 ac	50	I:175 II:217 III:296	I:10 II:12.5 III:15	I:737 II:867 III:1020	I:50 II:52 III:53	12
AAD400002	230 ac	50	I:235 II: 272 III:390	I:10 II:12.5 III:15	I:983 II:1156 III:1360	I:51 II:53 III:54	16
AAD400003	230 ac	50	I:272 II: 333 III:490	I:10 II:12.5 III:15	I:1225 II:1445 III:1700	I:53 II:54 III:56	20,6
AAD400004	230 ac	50	I:330 II: 393 III:590	I:10 II:12.5 III:15	I:1467 II:1734 III:2040	I:54 II:55 III:57	24,5

AUTOMATIC START KIT FOR AIR CURTAINS.

This kit, sold separately from the air curtain, allows you to switch the machine on and off by opening and closing the door.



INSTALLING AND COMMISSIONING THE AUTOMATIC START KIT (optional)

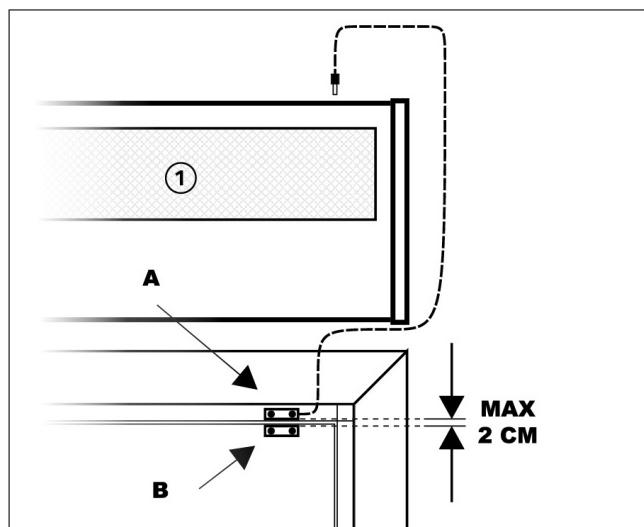

[1] Air curtain

Connect the wired sensor to the air curtain via jack.
 Attach the magnetic sensor A to the door casing or to a solid point with the door frame.
 Attach the second sensor to the moving part of the door leaving no more than 2 cm between the two sensors.
 When the “automatic start kit” is installed, the air curtain can be switched on and off with the opening / closing of the door.

SINGLE-PHASE POWER SUPPLY AND WIRING DIAGRAM

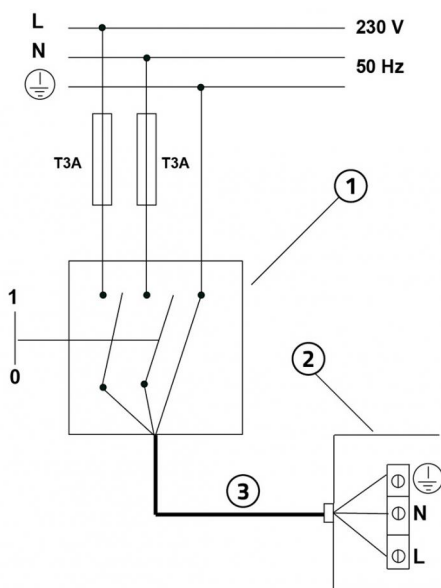

- [1] Omnipolar thermal magnetic protection switch compliant with EN 61508:1
- [2] Power cable 3x2.5 mm²
- [3] Electrical connection box

IMPORTANT!

During the electrical connection, the installer must comply with the polarities indicated by the plate in front of the power supply terminal board.

DISPLAY

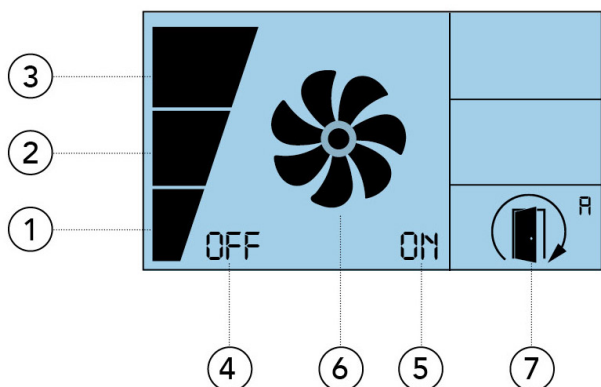

- [1] Speed 1: It turns on when the curtain is in operation and is set to the first speed
- [2] Speed 2: It turns on when the curtain is in operation and is set to the second speed
- [3] Speed 3: It turns on when the curtain is in operation and is set to the third speed
- [4] OFF The curtain is off
- [5] ON The curtain is on
- [6] FAN When the curtain is activated, the icon is fully on and the propellers turn off in sequence in counter-clockwise mode. Depending on the set speed (1, 2 or 3), the speed of the turning off of the icon will also vary.
- [7] AUTOMATIC START KIT When installing the automatic start kit (purchased separately) the speed control cannot be adjusted by the user. When the door is closed, the curtain is not active. When the door opens again, the curtain starts automatically at speed 3.

USING THE REMOTE CONTROL

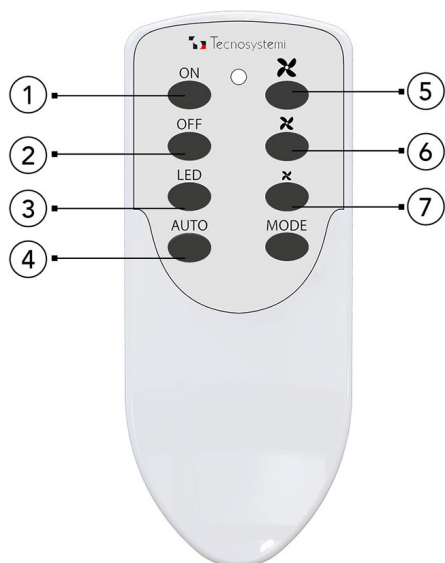

- [1] Air curtain ON
- [2] Air curtain OFF
- [3] Switching the LED on and off
- [4] ON/OFF Kit automatic start
- [5] Maximum speed
- [6] Medium speed
- [7] Low speed

USE OF THE APP (offline)

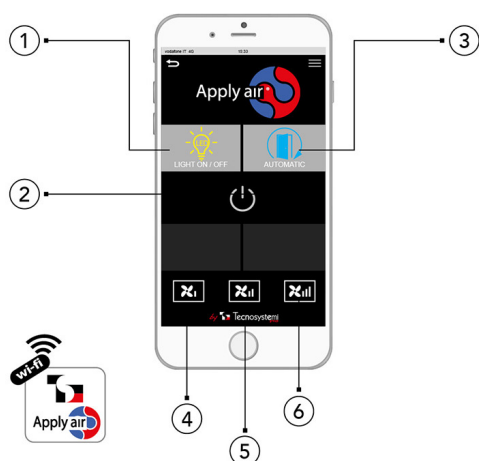

- [1] LIGHT ON/OFF turns on and off the LED bar in the air curtain
- [2] ON/OFF BUTTON turns on and off the air curtain
- [3] AUTOMATIC START turning the "automatic start kit" function on and off, which allows the air curtains to be switched on or off automatically when the door is opened/closed
- [4] Low speed
- [5] Medium speed
- [6] Maximum speed

WALL-MOUNTED DRILLING SPACING MODEL 900

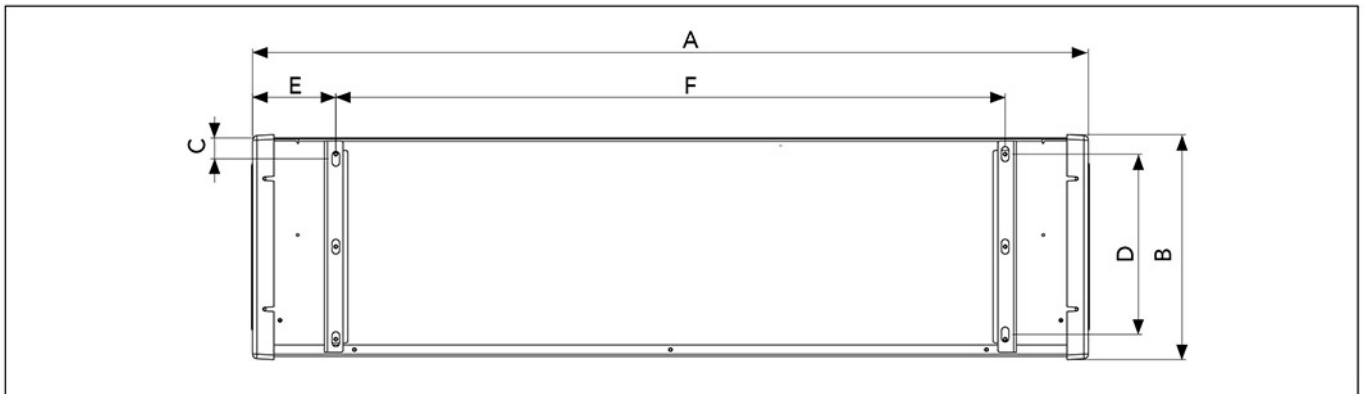

DIMENSIONAL TABLE

CODE	A [mm]	B [mm]	C [mm]	D [mm]	E [mm]	F [mm]
AAD400001	900	240	20	195	90	720

WALL-MOUNTED DRILLING SPACING MODEL 1200

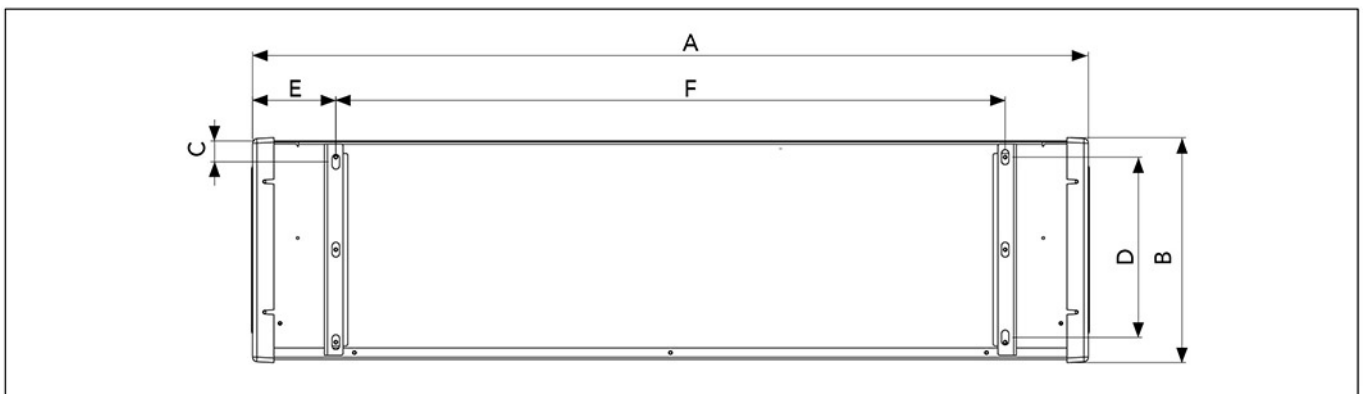

DIMENSIONAL TABLE

CODE	A [mm]	B [mm]	C [mm]	D [mm]	E [mm]	F [mm]
AAD400001	1200	240	20	195	235	720

WALL-MOUNTED DRILLING SPACING MODEL 1500

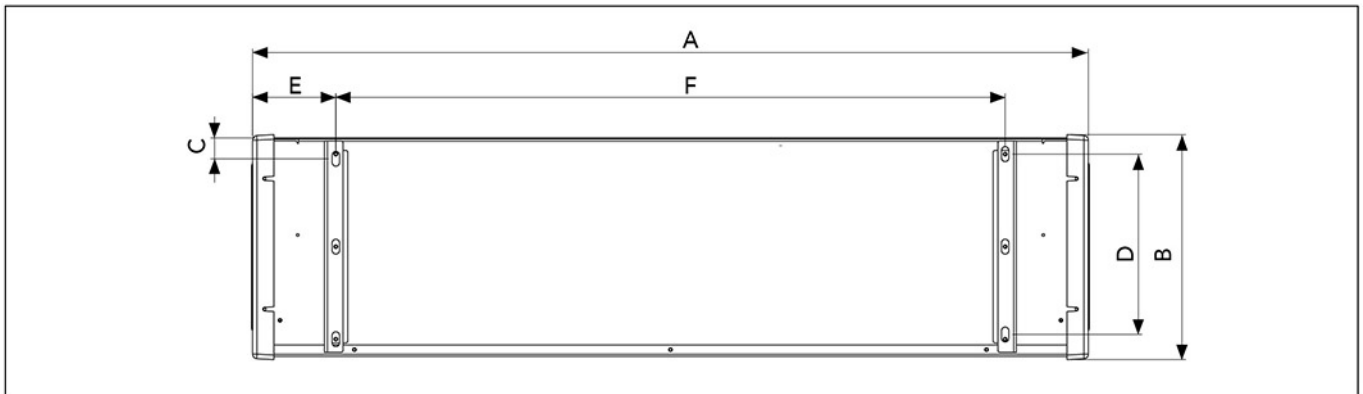

DIMENSIONAL TABLE

CODE	A [mm]	B [mm]	C [mm]	D [mm]	E [mm]	F [mm]
AAD400001	1200	240	20	195	235	720

WALL-MOUNTED DRILLING SPACING MODEL 2000

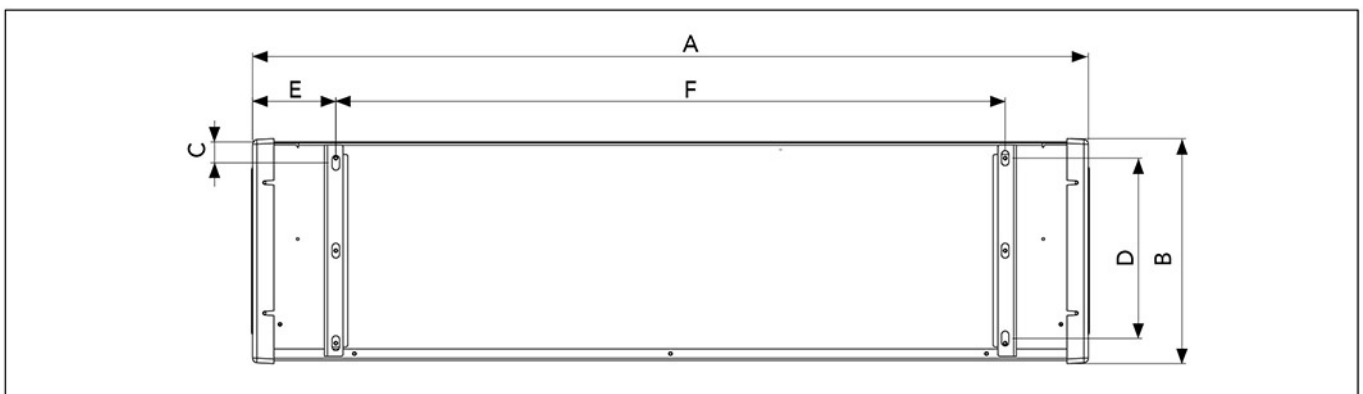

DIMENSIONAL TABLE

CODE	A [mm]	B [mm]	C [mm]	D [mm]	E [mm]	F [mm]
AAD400001	1500	240	20	195	150	600

ITEMS

CODE	DESCRIPTION
AAD400001	"AIRJET 900" CENTRIFUGAL AIR CURTAIN W/UPPER AIR INTAKE AND INCORPORATED LED LIGHT BAR, L.900
AAD400002	"AIRJET 1200" CENTRIFUGAL AIR CURTAIN W/UPPER AIR INTAKE AND INCORPORATED LED LIGHT BAR, L.1100
AAD400003	"AIRJET 1500" CENTRIFUGAL AIR CURTAIN W/UPPER AIR INTAKE AND INCORPORATED LED LIGHT BAR, L.1500
AAD400004	"AIRJET 2000" CENTRIFUGAL AIR CURTAIN W/UPPER AIR INTAKE AND INCORPORATED LED LIGHT BAR, L.2000

All rights relating to this publication are the exclusive property of Tecnosystemi SpA.
 Tecnosystemi SpA reserves the right to make changes at any time and without notice, for technical or commercial needs.