

SQUARE CANOVA

Diffuser in gypsum for plasterboard

- cod. PWD200031 - cod. PWD200032

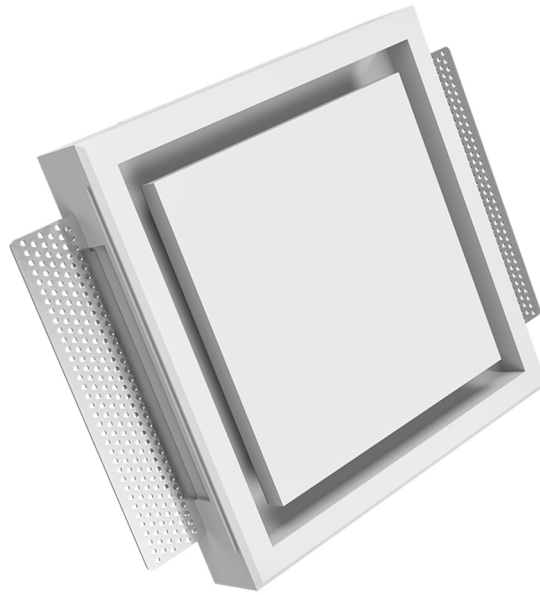

DESCRIPTION

The diffuser made of plaster, round and square, is an essential element to be inserted into the ceiling or walls in plasterboard.

It can be painted with the same color of the surface in which it is placed, integrating perfectly thanks to the minimal ring slit, necessary for the passage of air.

TECHNICAL SPECIFICATIONS

- Hidden and frameless
- High-quality gypsum products
- Can be installed on all types of ducts (steel, corrugated plastic, plenum)
- Connections for 100 mm and 125 mm ducts
- Can be used on single layer, double layer or variable thickness plasterboard
- Sturdy magnetic supports in stainless steel
- Side flaps for plaster fixing
- Diffusion profile ensuring uniform air distribution

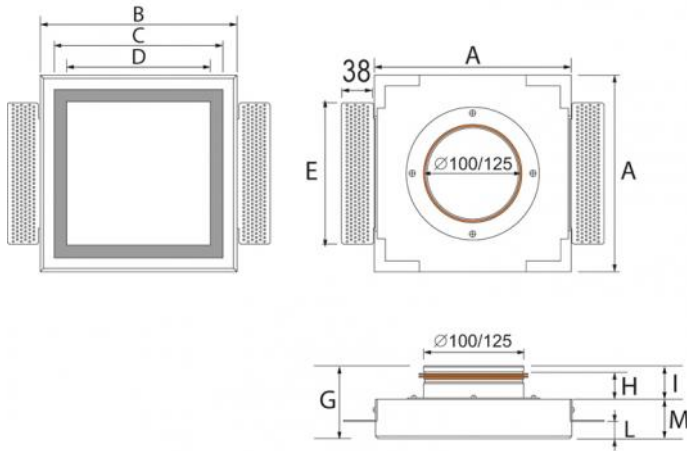

DIMENSIONS

CODE	A [mm]	B [mm]	C [mm]	D [mm]	E [mm]	G [mm]	H [mm]	I [mm]	L [mm]	M [mm]
PWD200031	240	206	176	176	173	89	35	41	13-26	48
PWD200032	240	206	176	176	173	89	35	41	13-26	48

AIR FLOW RATE DIAGRAMS

Canova Ø 100 (mandata / supply air)

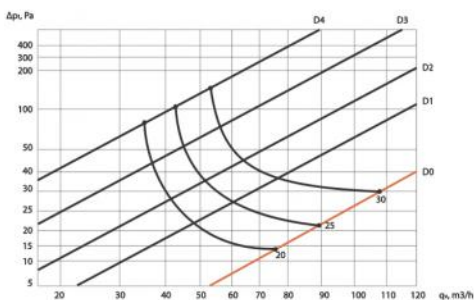

Canova Ø 125 (mandata / supply air)

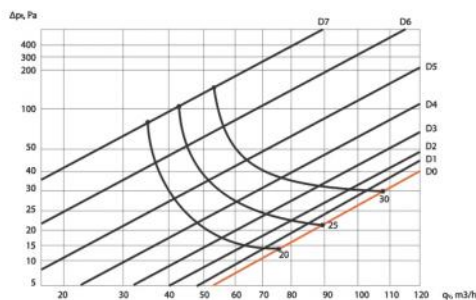

Canova Ø 100 (estrazione / exhaust air)

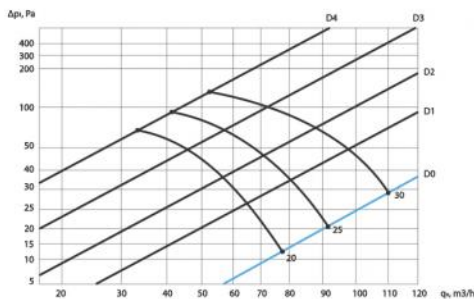

Canova Ø 125 (estrazione / exhaust air)

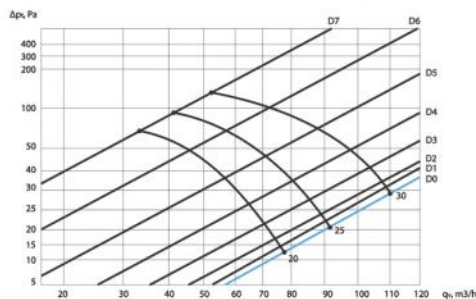

Canova Ø 100/125
velocità / velocity m/s

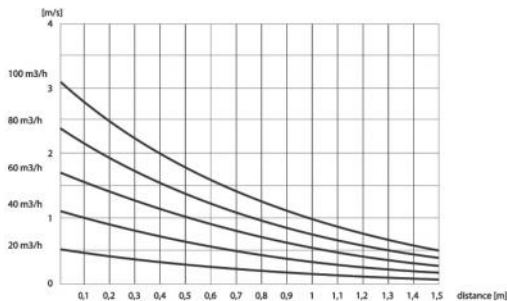

ITEMS

CODE	DESCRIPTION
PWD200031	DIFFUSER "CANOVA" SQUARE Ø100
PWD200032	DIFFUSER "CANOVA" SQUARE Ø125

All rights relating to this publication are the exclusive property of Tecnosystemi SpA. Tecnosystemi SpA reserves the right to make changes at any time and without notice, for technical or commercial needs.