

PICO PRO

Ventilation units with wall-mounted puntual heat recovery

- cod. ACD100056 - cod. ACD100057 - cod. ACD100058
- cod. CDE00113 - cod. RIC00190 - cod. RIC00191
- cod. RIC00192 - cod. C20002333 - cod. C20002336
- cod. C20002324

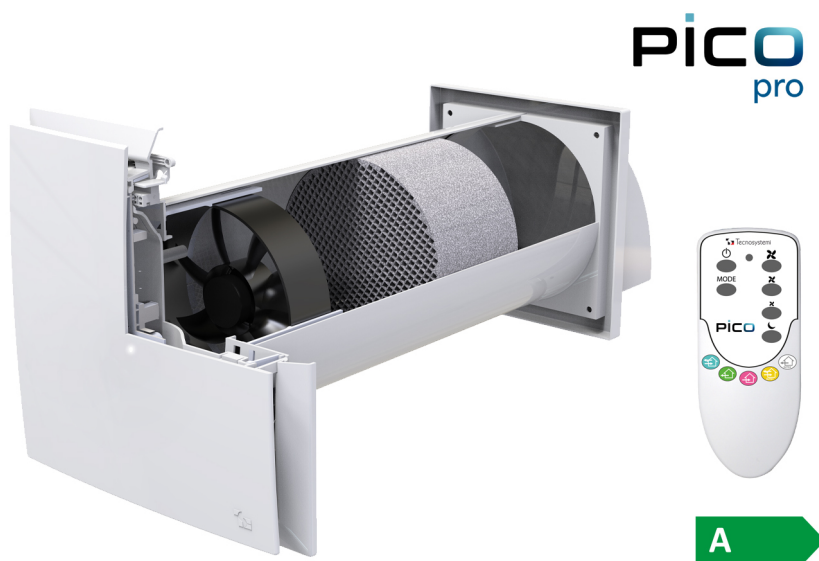

DESCRIPTION

PICO PRO is an innovative system designed to improve thermal comfort and air quality in residential environments. PICO PRO is able to operate in both directions, which means that it can be used to ventilate and recover the heat of the environment according to the need. This allows you to maintain a comfortable microclimate in any season.

Energy Saving: This system is designed to maximize energy saving, thus reducing the costs associated with heating and cooling of the interior spaces. Thanks to its efficient operation, it contributes to reducing environmental impact.

Optimized Ventilation: PICO PRO ensures effective ventilation and adequate air exchange inside the rooms, improving air quality and contributing to the well-being of the occupants.

High Efficiency: The vacuum extractor integrated in PICO PRO offers a high performance, with the extraction capacity that can reach up to 90%. This is made possible by the presence of a honeycomb heat exchanger made of ceramic material, which maximizes thermal efficiency.

Easy Installation and Maintenance: PICO PRO is designed to be installed with ease and requires simple maintenance. This simplifies system management, reducing maintenance costs over time.

The connection to the electrical network to the device is made directly from the prearranged clamp integrated in the wall dashboard, to ensure quick assembly and maintenance of the PICO.

The ventilation unit front panel is made from white ABS.

The unit is equipped with an automatic closing damper and remote control, supplied as standard.

The wall through pipe is 50 cm long and contains the ceramic heat exchanger and grade G2 incorporated filters.

An external element with rain guard completes the installation.

All the functions of the Pico can also be controlled via APP via remote or local wifi connection directly from your smartphone or tablet in a simple and intuitive way.

Simply download the Tecnosystemi application and pair your device.

FUNCTIONAL FEATURES

- For wall installation, minimum installation wall thickness: 270 mm
- Front wall thickness 35 mm
- Available with flow rates from 30 to 60 m³/h
- Energy Class A
- Wi-fi control mode 2.4 GHz via APP: local or remote connection
- Integration Voice assistants and Google Home
- Automatic closing damper
- Functions: Comfort - Humidity threshold - Natural recirculation - Night mode
- MASTER function / SLAVE: Possibility to connect in cascade via WIFI up to 4 slaves
- Slaves configurable in synchronous or asynchronous mode.
- Humidity threshold can be set to 3 different values: 40 - 50 - 60%
- Heat exchanger made of high-efficiency ceramic
- Built-in grade G2 filters
- Fan with low energy consumption, suitable for continuous operation
- Equipped with remote control
- RGB LED on front for mode display
- 4-speed, min, med, max and night mode, adjustable via app
- Mounting Hole Sections Ø103 - Ø128 - Ø153

DIMENSIONS PICO PRO 30 / 45 / 60

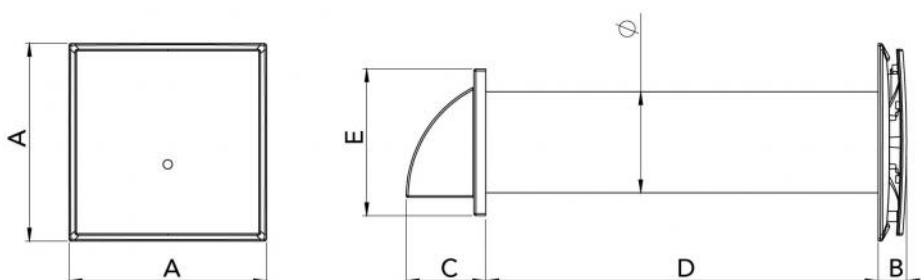

MODEL	A [mm]	B [mm]	C [mm]	D [mm]	E [mm]	Ø [mm]	WEIGHT [kg]
PICO PRO 30	250	35	86	500	154	103	2,0
PICO PRO 45	250	35	101	500	186	128	2,2
PICO PRO 60	250	35	101	500	186	153	3,2

REFERENCES

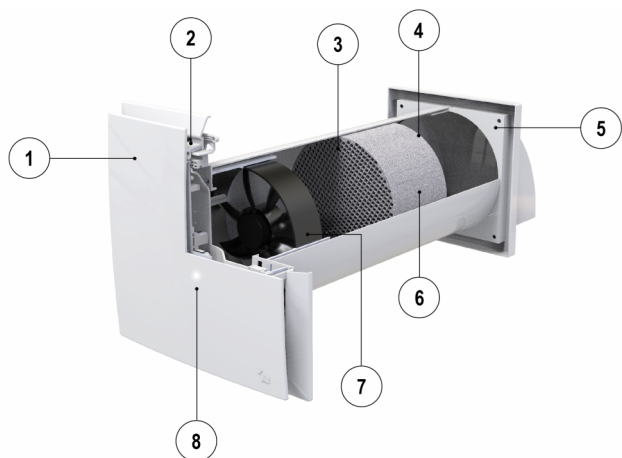

- [1] Aesthetic front panel
- [2] Mechanical damper
- [3] Filter 1
- [4] Filter 2
- [5] External grille
- [6] Exchanger pack
- [7] Bidirectional fan
- [8] RGB mode LEDs

TECHNICAL DATA

	DATA
Power supply	90-240 Vac +/- 10%, 50/60 Hz
Insulation	II
Protection rating	IPX4
Type of installation	Fixed
Control	Remote control / App
Communications	WiFi 2.4 GHz
Messages	Multi-colour RGB LED
Motors	Brushless DC PWM controlled
Exchanger type	High-efficiency ceramics
Body material	ABS
Operating temperature	-10°C / +40°C C13(-10T40)
Relative operating humidity at room temperature of 25° C	85 rH%
Storage temperature	min -20°C - max 70°C
Service class	CONTINUOUS
Minimum wall thickness	270mm

PICO PRO 30

TECHNICAL DATA	Standby	NIGHT		minimum speed		Average speed		Maximum speed	
Mode	/	Extraction	Immission	Extraction	Immission	Extraction	Immission	Extraction	Immission
Consumption [W]	<1	1.5		2		3		4	
Air flow rate [m³/h]	/	6		10		20		30	
Sound power [dB(A)] @2m	/	18	19	22	23	26	27	29	32
ENERGY RATING SEC	A								
Type	Bidirectional UVR								
Type of recovery system	Regenerative type HRC3b								
Filtration class	G2								
Filter signal	Red flashing light indication on front fixture								
Internet address with pre-assembly and disassembly instructions	www.tecnosystemi.com								

PICO PRO 45

TECHNICAL DATA	Standby	NIGHT		minimum speed		Average speed		Maximum speed	
Mode	/	Extraction	Immission	Extraction	Immission	Extraction	Immission	Extraction	Immission
Consumption [W]	<1	1.5		2		3		4.5	
Air flow rate [m³/h]	/	8		20		30		45	
Sound power [dB(A)] @2m	/	20	22	24	27	28	30	35	37
ENERGY RATING SEC	A								
Type	Bidirectional UVR								
Type of recovery system	Regenerative type HRC3b								
Filtration class	G2								
Filter signal	Red flashing light indication on front fixture								
Internet address with pre-assembly and disassembly instructions	www.tecnosystemi.com								

PICO PRO 60

TECHNICAL DATA	Standby	NIGHT		minimum speed		Average speed		Maximum speed	
Mode	/	Extraction	Immission	Extraction	Immission	Extraction	Immission	Extraction	Immission
Consumption [W]	<1	1.7		3		4.5		7	
Air flow rate [m³/h]	/	11		30		40		60	
Sound power [dB(A)] @2m	/	24	28	30	32	35	38	40	41
ENERGY RATING SEC	A								
Type	Bidirectional UVR								
Type of recovery system	Regenerative type HRC3b								
Filtration class	G2								
Filter signal	Red flashing light indication on front fixture								
Internet address with pre-assembly and disassembly instructions	www.tecnosystemi.com								

























NOTES:

Data according to Regulation (EU) 1253/2014 and Regulation (EU) 1254/2014.
N/A = not applicable to the type of product

EASILY CONTROLLED WITH REMOTE CONTROL OR WITH APP TECNOSYSTEMI



Functionality

FUNCTION	PICO BASIC	PICO PRO	PICO PRO+		LED
HEAT RECOVERY		✓			
EXTRACTION		✓			
IMMISSION		✓			
HEAT RECOVERY HUMIDITY THRESHOLD		✓			
HUMIDITY EXTRACTION THRESHOLD		✓			
AIR EXCHANGE	/		✓		/
FREE COOLING	/		✓		
FREE HEATING	/		✓		
CO2 HEAT RECOVERY THRESHOLD	/		✓		
CO2 EXTRACTION THRESHOLD	/		✓		
CO2 HUMIDITY HEAT RECOVERY THRESHOLD	/		✓		
CO2 HUMIDITY EXTRACTION THRESHOLD	/		✓		
NIGHT MODE		✓			/
MASTER/SLAVE CASCADE MODE		✓			/
FILTER MAINTENANCE INDICATION		✓			/
DEACTIVATING / ACTIVATING WiFi		✓			/
LED SWITCH-OFF		✓			/
INTEGRATION WITH VOICE ASSISTANTS (Google HOME - AMAZON ALEXA)		✓			/
DAMPER	/		✓		/
REMOTE CONTROL	(1)		✓		/

ITEMS

CODE	DESCRIPTION
ACD100056	HEAT RECOVERY UNIT - PICO PRO 30 - PICO PRO 30
ACD100057	HEAT RECOVERY UNIT - PICO PRO 45 - PICO PRO 45
ACD100058	HEAT RECOVERY UNIT - PICO PRO 60 - PICO PRO 60
CDE00113	REMOTE CONTROL FOR PICO 2024
RIC00190	CERAMIC HEAT EXCHANGER WITH FILTERS FOR "PICO HP2 30" AND "PICO CLEAN 30"
RIC00191	CERAMIC HEAT EXCHANGER WITH FILTERS FOR "PICO HP2 55" AND "PICO CLEAN 55"
RIC00192	CERAMIC HEAT EXCHANGER WITH FILTERS FOR "PICO HP2 80" AND "PICO CLEAN 80"
C20002333	SPARE FILTER CLASS 3 FOR PICO HP2-30 - Ø 100
C20002336	SPARE FILTER CLASS 3 FOR PICO HP2-55 - Ø 125
C20002324	SPARE FILTER CLASS 3 FOR PICO HP2-80 - Ø 150

All rights relating to this publication are the exclusive property of Tecnosystemi SpA.
 Tecnosystemi SpA reserves the right to make changes at any time and without notice, for technical or commercial needs.