

RAPID COMPLETION KIT for PROAIR PACK 4 zones with \varnothing 200 connections and grilles in anti-condensation ABS plastic with adjustable flaps

- cod. GAC500024

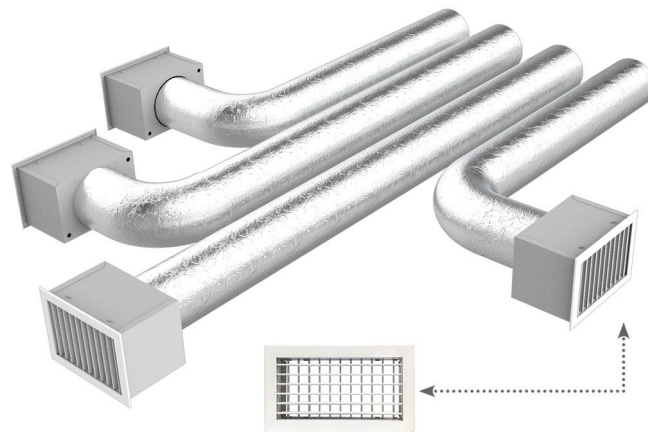

DESCRIPTION

The "Rapid Kits" are designed for "Proair Pack" ventilation systems.

When creating a ducted air conditioning system, the pre-packaged kits facilitate the customer in choosing the items necessary for the distribution of air in the individual environments, without the possibility of error.

The "Rapid Kits" are available for the "Proair Pack" systems with 2 - 3 - 4 - 5 - 6 zones with circular connections of \varnothing 125 / 150 / 200 mm.

The possibility of choosing between delivery grilles with adjustable flaps, with 15° inclined flaps and with linear diffusers with 2 slots, provides everything needed to create and complete the installation of the ducted unit with high quality products, with every detail covered from a technical, functional and aesthetic point of view.

The regulation of the temperature and air flow of the single zone is managed by the "Proair Pack" system chronothermostats that are used to achieve the maximum performance and optimum comfort inside homes or offices.

ATTENTION: the plenum is included in the "Proair Pack"

THE KIT CONSISTS OF:

- 4 ABS plastic supply grilles, installation hole 300 x 200 mm, outer size 332 x 232 mm COD. PWD100014
- 4 insulated plenums with rear coupling for grille (332 x 232) COD. PWD402433
- 1 double-wall aluminium flexible hose \varnothing 203 mm 10 m COD. 11152204
- 1 white aluminium intake grille with filter installation hole 600 x 400 mm, external measurement 632 x 432 mm COD.

WB11161525

• 8 hose clamps

Customisable on request

ITEMS

CODE	DESCRIPTION
GAC500024	KIT RAPID 4 ZONES - (COUPLING Ø 200 mm)

All rights relating to this publication are the exclusive property of Tecnosystemi SpA.
Tecnosystemi SpA reserves the right to make changes at any time and without notice, for technical or commercial needs.