

SCHEMA TECNICA

rev. 00 - 18/10/2022



Ventilatore in linea a flusso misto

30360150 - 30360160 - 30360170
30360250 - 30360260

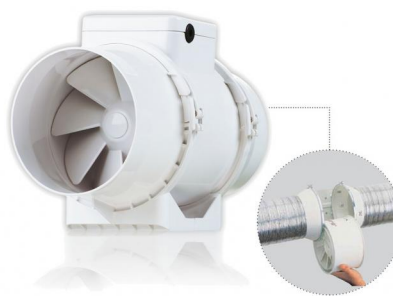

CARATTERISTICHE TECNICHE:

- Realizzato in ABS
- Facile da installare e da ispezionare
- 2 velocità
- Azionabile tramite interruttore ON/ OFF (non fornito)
- Consigliato per cucine, bagni, uffici, negozi

GRAFICI DI PORTATA

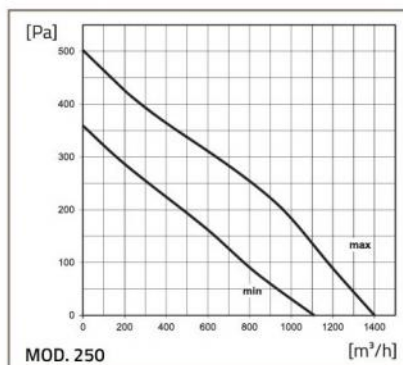
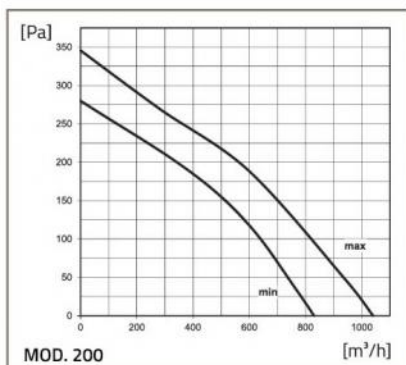
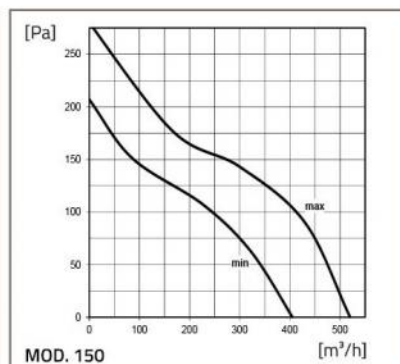
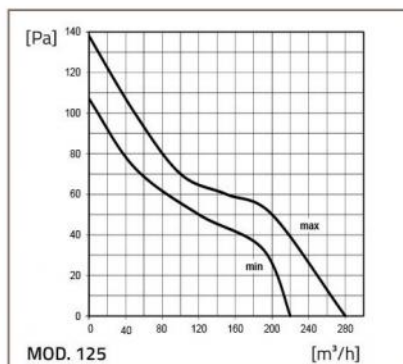
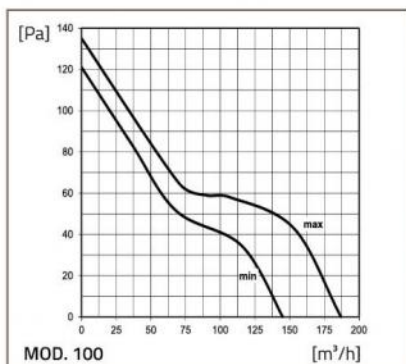

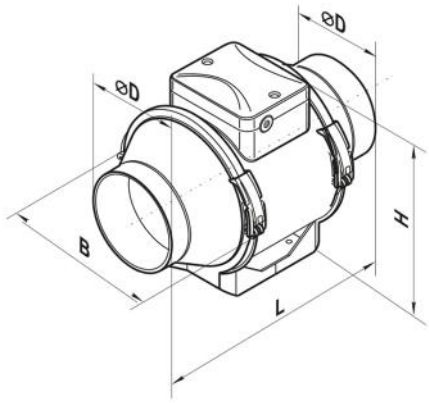

DIMENSIONI

CODICE	Ø D [mm]	B [mm]	H [mm]	L [mm]	PESO [kg]
30360150	96	167	190	246	1,4
30360160	123	167	190	246	1,8
30360170	146	223	250	295	3,2
30360250	199	239	261	295,5	4
30360260	247	287	323	383	7,8

DATI TECNICI

MODELLO	Ø 100		Ø 125		Ø 150		Ø 200		Ø 250	
Alimentazione [V]	230	230	230	230	230	230	230	230	230	230
Frequenza [Hz]	50	50	50	50	50	50	50	50	50	50
Velocità	min.	max.	min.	max.	min.	max.	min.	max.	min.	max.
Potenza [W]	21	33	23	37	30	60	76	108	125	177
Corrente assorbita [A]	0,11	0,21	0,18	0,27	0,17	0,27	0,34	0,48	0,54	0,79
Portata aria [m³/h]	145	187	220	280	405	520	830	1040	1110	1400
RPM	2180	2385	1950	2455	1680	2460	1915	2380	1955	2440
Livello sonoro 3 m [dB(A)]	27	36	28	37	33	44	45	52	47	55
Temperatura max d'esercizio [°C]	60	60	60	60	60	60	60	60	60	60
Grado di protezione [IP]	X4	X4	X4	X4	X4	X4	X4	X4	X4	X4

ARTICOLI

CODICE	DESCRIZIONE
30360150	VENTILATORE "IN LINEA" A FLUSSO MISTO Ø100
30360160	VENTILATORE "IN LINEA" A FLUSSO MISTO Ø125
30360170	VENTILATORE "IN LINEA" A FLUSSO MISTO Ø150
30360250	VENTILATORE "IN LINEA" A FLUSSO MISTO Ø200
30360260	VENTILATORE "IN LINEA" A FLUSSO MISTO Ø250